

ROBOTICS

# Product manual

## IRB 14000 gripper

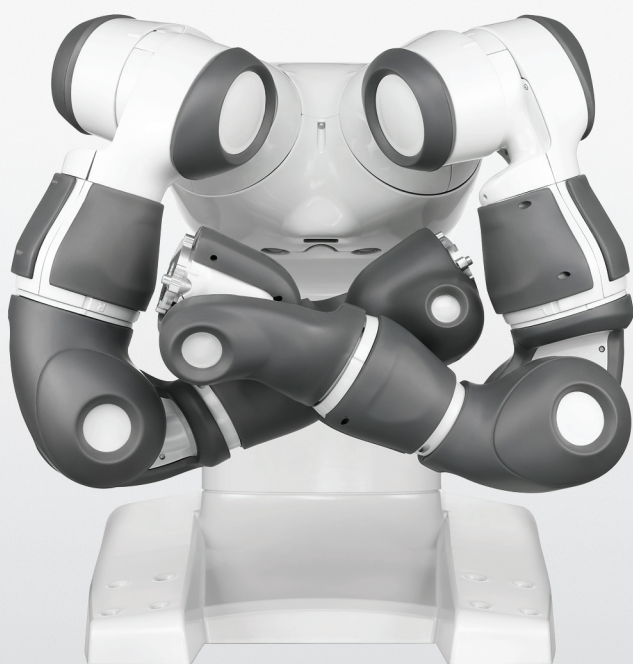

Trace back information:  
Workspace 21B version a6  
Checked in 2021-05-31  
Skribenta version 5.4.005

**Product manual**  
**IRB 14000 gripper**  
IRC5

Document ID: 3HAC054949-001  
Revision: M

The information in this manual is subject to change without notice and should not be construed as a commitment by ABB. ABB assumes no responsibility for any errors that may appear in this manual.

Except as may be expressly stated anywhere in this manual, nothing herein shall be construed as any kind of guarantee or warranty by ABB for losses, damage to persons or property, fitness for a specific purpose or the like.

In no event shall ABB be liable for incidental or consequential damages arising from use of this manual and products described herein.

This manual and parts thereof must not be reproduced or copied without ABB's written permission.

Keep for future reference.

Additional copies of this manual may be obtained from ABB.

Original instructions.

© Copyright 2015-2021 ABB. All rights reserved.  
Specifications subject to change without notice.



# Table of contents

Overview of this manual .....	7
Product documentation .....	11
<b>1 Safety</b> .....	<b>13</b>
1.1 Introduction to safety information .....	13
1.2 General safety risks .....	14
1.2.1 Safety risks during installation and service work on the IRB 14000 gripper .....	14
1.2.2 Safety risks related to tools/work pieces .....	15
1.2.3 Risks associated with live electric parts .....	16
<b>2 Installation and commissioning</b> .....	<b>17</b>
2.1 Introduction .....	17
2.2 Unpacking .....	18
2.2.1 Pre-installation procedure .....	18
2.2.2 Requirements .....	20
2.3 Technical data .....	21
2.3.1 General .....	21
2.3.2 Servo module .....	25
2.3.3 Vacuum module .....	28
2.3.4 Vision module .....	29
2.3.5 Fingers .....	32
2.4 On-site installation .....	33
2.4.1 Air and power supply .....	33
2.4.2 Recommended standard tightening torque .....	34
2.4.3 Mounting the gripper .....	35
2.4.4 Mounting the fingers .....	41
2.4.5 Mounting tools to the vacuum module .....	42
2.5 IRB 14000 gripper FlexPendant application .....	44
2.5.1 Installing IRB 14000 gripper FlexPendant application .....	45
2.5.2 Updating IRB 14000 gripper FlexPendant application .....	46
2.5.3 IRB 14000 gripper FlexPendant application GUI .....	47
2.6 Commissioning .....	52
2.6.1 Software commissioning .....	52
2.6.2 Firmware update .....	53
2.6.3 System commissioning .....	57
<b>3 Maintenance</b> .....	<b>61</b>
3.1 Inspection activities .....	61
<b>4 Repair</b> .....	<b>63</b>
4.1 Introduction .....	63
4.2 Replacing the filter and suction cup .....	64
4.3 Replacing the fingers .....	69
4.4 Replacing the shell .....	75
4.5 Replacing the pneumatic block .....	82
4.6 Replacing the camera .....	94
4.7 Replacing the servo base .....	102
<b>5 RAPID references</b> .....	<b>115</b>
5.1 Overview .....	115
5.2 Instructions .....	117
5.2.1 RAPID instructions for grippers .....	117
5.2.1.1 g_Init - Initialize the gripper .....	117
5.2.1.2 g_JogIn - Jog the gripper to move inward .....	119
5.2.1.3 g_JogOut - Jog the gripper to move outward .....	120

## Table of contents

---

5.2.1.4	g_MoveTo - Move the gripper to a target position .....	121
5.2.1.5	g_GripIn - Jog the gripper to grip inward .....	123
5.2.1.6	g_GripOut - Jog the gripper to grip outward .....	126
5.2.1.7	g_Calibrate - Calibrate the gripper .....	129
5.2.1.8	g_Stop - Stop the gripper .....	130
5.2.1.9	g_SetMaxSpd - Set the maximum speed .....	131
5.2.2	RAPID instructions for pneumatic modules .....	132
5.2.2.1	g_BlowOn1 - Turn on blowing channel 1 .....	132
5.2.2.2	g_BlowOff1 - Turn off blowing channel 1 .....	133
5.2.2.3	g_BlowOn2 - Turn on blowing channel 2 .....	134
5.2.2.4	g_BlowOff2 - Turn off blowing channel 2 .....	135
5.2.2.5	g_VacuumOn1 - Turn on vacuum channel 1 .....	136
5.2.2.6	g_VacuumOff1 - Turn off vacuum channel 1 .....	137
5.2.2.7	g_VacuumOn2 - Turn on vacuum channel 2 .....	138
5.2.2.8	g_VacuumOff2 - Turn off vacuum channel 2 .....	139
5.3	Functions .....	140
5.3.1	RAPID functions for servo module .....	140
5.3.1.1	g_IsCalibrated - Get gripper calibration status .....	140
5.3.1.2	g_GetPos - Get current gripper position .....	141
5.3.1.3	g_GetSpd - Get current gripper speed .....	142
5.3.1.4	g_GetState - Get current gripper status .....	143
5.3.1.5	g_GetErrID - Get current gripper error ID .....	145
5.3.2	RAPID functions for pneumatic module .....	147
5.3.2.1	g_GetPressure1 - Get vacuum pressure 1 .....	147
5.3.2.2	g_GetPressure2 - Get vacuum pressure 2 .....	148
5.3.3	RAPID functions for camera module .....	149
5.3.3.1	g_IsCamOnline - Get handheld camera connection status .....	149
<b>6</b>	<b>Decommissioning</b> .....	<b>151</b>
6.1	Environmental information .....	151
<b>7</b>	<b>Reference information</b> .....	<b>153</b>
7.1	Introduction .....	153
7.2	Unit conversion .....	154
7.3	Standard toolkit .....	155
<b>8</b>	<b>Spare parts</b> .....	<b>157</b>
8.1	Introduction .....	157
8.2	Spare part lists and illustrations .....	158
8.2.1	Parts .....	158
<b>Index</b>		<b>163</b>

---

# Overview of this manual

---

## About this manual

This manual contains instructions for:

- mechanical and electrical installation of the IRB 14000 gripper
- maintenance of the IRB 14000 gripper
- mechanical and electrical repair of the IRB 14000 gripper

---

## Usage

This manual should be used during:

- installation to make the IRB 14000 gripper ready for operation
- maintenance work
- repair work and calibration.

---

## Who should read this manual?

This manual is intended for:

- installation personnel
- maintenance personnel
- repair personnel.

---

## Prerequisites

A maintenance/repair/installation craftsman working with the IRB 14000 gripper must:

- be trained by ABB and have the required knowledge of mechanical and electrical installation/repair/maintenance work.

---

## Product manual scope

The manual covers all variants and designs of the IRB 14000 gripper. Some variants and designs may have been removed from the business offer and are no longer available for purchase.

---

## Organization of chapters

The manual is organized in the following chapters:

Chapter	Contents
Safety	Safety information that must be read through before performing any installation or service work on the IRB 14000 gripper. Contains general safety aspects as well as more specific information on how to avoid personal injuries and damage to the product.
Installation and commissioning	Required information about installation of the IRB 14000 gripper.
Maintenance	Step-by-step procedures that describe how to perform maintenance of the IRB 14000 gripper. Based on a maintenance schedule that may be used to plan periodical maintenance.
Repair	Step-by-step procedures that describe how to perform repair activities of the IRB 14000 gripper. Based on available spare parts.

*Continues on next page*

## Overview of this manual

Continued

Chapter	Contents
Operation	RAPID reference information and operation using FlexPendant for the IRB 14000 gripper.
Decommissioning	Environmental information about the IRB 14000 gripper and its components.
Reference information	Useful information when performing installation, maintenance or repair work. Includes lists of necessary tools, additional documents, safety standards, etc.
Spare parts	Reference to the spare part list for the IRB 14000 gripper.

## References

Documentation referred to in the manual, is listed in the table below.

Document name	Document ID
<i>Product manual - IRB 14000</i>	3HAC052983-001
<i>Product specification - IRB 14000</i>	3HAC052982-001
<i>Operating manual - IRB 14000</i>	3HAC052986-001
<i>Technical reference manual - System parameters</i>	3HAC050948-001
<i>Safety manual for robot - Manipulator and IRC5 or OmniCore controller<sup>i</sup></i>	3HAC031045-001

<sup>i</sup> This manual contains all safety instructions from the product manuals for the manipulators and the controllers.

## Revisions

Revision	Description
-	First edition.
A	Changes made in this revision. <ul style="list-style-type: none"><li>• Modified the article numbers for the whole gripper assemblies. For details, see "Required spare part" in <a href="#">Installing the gripper on page 37</a> and <a href="#">Gripper assembly</a>.</li><li>• Added camera dimensions in <a href="#">Camera, dimensions on page 29</a>.</li><li>• Added figures in procedures of removing and refitting the gripper. For details, see "Procedure" in <a href="#">Installing the gripper on page 37</a> as well as "Removing the whole gripper" and "Refitting the whole gripper" in each specific repair procedure in <a href="#">Repair on page 63</a>.</li><li>• Added RAPID references for gripper states in <a href="#">Servo module tab page on page 49</a> and <a href="#">Returned value on page 143</a>.</li><li>• Added RAPID references for gripper error IDs in <a href="#">Error handling on page 145</a>.</li></ul>
B	Changes made in this revision. <ul style="list-style-type: none"><li>• Modified the program execution for the instruction <code>Hand_Initialize</code>. See <a href="#">g_Init - Initialize the gripper on page 117</a>.</li><li>• Modified the list of the screws used on IRB 14000 gripper.</li></ul>
C	Changes made in this revision. <ul style="list-style-type: none"><li>• Modified the maximum speed of IRB 14000 gripper from 20 mm/s to 25 mm/s.</li></ul>

Continues on next page

Revision	Description
D	<p>Published in release R16.2. The following updates are done in this revision:</p> <ul style="list-style-type: none"> <li>• Added a note of wear parts for gripper fingers. See <a href="#">Parts on page 158</a>.</li> <li>• Removed spare part items for gripper parts except fingers, because the parts are not provided as spare parts anymore. Also related repair procedures are removed.</li> <li>• Removed screw specification; added information about screws for fingers in finger replacement procedure. See <a href="#">Refitting the fingers on page 71</a>.</li> <li>• Added version information displayed on the main page of the FlexPendant application GUI. See <a href="#">Main page on page 47</a>.</li> <li>• Added a new firmware update method, that is, FTP method. See <a href="#">FTP method on page 53</a>.</li> <li>• Updated some GUI figures about the Servo module tab page.</li> <li>• Introduced a shorter name for each RAPID instruction/function. See <a href="#">RAPID references on page 115</a>.</li> </ul>
E	<p>Published in release R17.2. The following updates are done in this revision:</p> <ul style="list-style-type: none"> <li>• Added the description of fast switch between left and right gripper control view.</li> <li>• Updated the value of air supply.</li> </ul>
F	<p>Published in release R18.1. The following updates are done in this revision:</p> <ul style="list-style-type: none"> <li>• Updated the default value of argument [<code>\holdForce</code>] of the instruction <code>g_Init</code>, from 10 N to 20 N.</li> <li>• Added the argument [<code>\Grip</code>] to instructions <code>g_Init</code> and <code>g_Calibrate</code>.</li> <li>• Added error handling descriptions for errors <code>ERR_HAND_WRONGSTATE</code> and <code>FAILEDGRIPINWARD</code> to the instruction <code>g_GripIn</code>.</li> <li>• Added error handling descriptions for errors <code>ERR_HAND_WRONGSTATE</code> and <code>FAILEDGRIPOUTWARD</code> to the instruction <code>g_GripIOut</code>.</li> <li>• Added spare part silicon rubber plug (3HAC063051-001).</li> </ul>
G	<p>Changes made in this revision.</p> <ul style="list-style-type: none"> <li>• Introduced new spare parts.</li> </ul>
H	<p>Published in release R18.2. The following updates are done in this revision:</p> <ul style="list-style-type: none"> <li>• Updated the air supply to the robot from 5-6 bar to 5.5-6 bar.</li> <li>• Updated the minimum value of air pressure from 5 bar to 5.5 bar, which is supplied to the AIR interfaces before conducting system commissioning to vacuum module.</li> <li>• Updated the maximum allowed reading value of <b>Gas pressure</b> from 60 kPa to 70 kPa when the object is successfully picked up by vacuum module.</li> <li>• Updated figure flange hole configuration figure.</li> <li>• Updated cautions for install and remove the grippers.</li> <li>• Added information about program execution on the virtual controller.</li> <li>• Updated basic example for <code>g_GetPressure1</code>.</li> <li>• Removed spare part items for whole gripper assemblies, because the whole assemblies are not provided as spare parts anymore.</li> </ul>

Continues on next page

Revision	Description
J	Published in release 19B. The following updates are made in this revision: <ul style="list-style-type: none"><li>• Added new spare part M2x7 screw (3HAC051700-001).</li><li>• Updated program execution description for <code>g_GetPressure1</code> and <code>g_GetPressure2</code>.</li><li>• Removed description of spare part versions for servo base and shell complete because compatible spare parts will be provided.</li></ul>
K	Published in release 20B. The following updates are made in this revision: <ul style="list-style-type: none"><li>• O-ring 3x2 (3HAB3772-174) changed to O-ring 4x2 (3HAC063220-001).</li></ul>
L	Published in release 21A. The following updates are made in this revision: <ul style="list-style-type: none"><li>• The instruction <code>g_SetForce</code> is no longer supported and therefore removed from the manual.</li></ul>
M	Published in release 21B. The following updates are made in this revision: <ul style="list-style-type: none"><li>• Added new spare parts vacuum sensor (3HAC047823-001), connector board (3HAC051609-001), FFC for pneumatic block connector board (3HAC051610-002) and FFC for camera (3HAC054157-002); related repair procedures, spare part list and spare part images are also updated.</li></ul>

---

# Product documentation

---

## Categories for user documentation from ABB Robotics

The user documentation from ABB Robotics is divided into a number of categories. This listing is based on the type of information in the documents, regardless of whether the products are standard or optional.



### Tip

All documents can be found via myABB Business Portal, [www.abb.com/myABB](http://www.abb.com/myABB).

---

## Product manuals

Manipulators, controllers, DressPack/SpotPack, and most other hardware is delivered with a **Product manual** that generally contains:

- Safety information.
- Installation and commissioning (descriptions of mechanical installation or electrical connections).
- Maintenance (descriptions of all required preventive maintenance procedures including intervals and expected life time of parts).
- Repair (descriptions of all recommended repair procedures including spare parts).
- Calibration.
- Decommissioning.
- Reference information (safety standards, unit conversions, screw joints, lists of tools).
- Spare parts list with corresponding figures (or references to separate spare parts lists).
- References to circuit diagrams.

---

## Technical reference manuals

The technical reference manuals describe reference information for robotics products, for example lubrication, the RAPID language, and system parameters.

---

## Application manuals

Specific applications (for example software or hardware options) are described in **Application manuals**. An application manual can describe one or several applications.

An application manual generally contains information about:

- The purpose of the application (what it does and when it is useful).
- What is included (for example cables, I/O boards, RAPID instructions, system parameters, software).
- How to install included or required hardware.
- How to use the application.
- Examples of how to use the application.

*Continues on next page*

---

### Operating manuals

The operating manuals describe hands-on handling of the products. The manuals are aimed at those having first-hand operational contact with the product, that is production cell operators, programmers, and troubleshooters.



# 1 Safety

## 1.1 Introduction to safety information

---

### Overview

This chapter describes the safety information specific to the IRB 14000 gripper only. It does not contain complete safety information for the IRB 14000 robot system. The following additional documents are essential for correct and safe usage of the IRB 14000 robot system, including the gripper:

- *Product manual - IRB 14000*
- *Operating manual - IRB 14000*

---

### Disposition

The safety information in this manual is divided into two categories:

- General safety aspects, important to attend to before performing any service work on the grippers. These are applicable for all service works and can be found in the section [General safety risks on page 14](#).
- Specific safety information, pointed out in the procedures. How to avoid and eliminate the danger is described directly in the procedure.

# 1 Safety

---

## 1.2.1 Safety risks during installation and service work on the IRB 14000 gripper

## 1.2 General safety risks

### 1.2.1 Safety risks during installation and service work on the IRB 14000 gripper

---

#### Overview

This section includes information about general safety risks to be considered when performing installation and service work on the IRB 14000 gripper.

---

#### General risks during installation and service

- The instructions in the product manual in chapters [Installation and commissioning on page 17](#), and [Repair on page 63](#) must always be followed.
- Those in charge of operations must make sure that safety instructions are available for the installation in question.
- Those who install the IRB 14000 gripper must have the appropriate training for the robot system in question and in any safety matters associated with it.
- The power supply of 24 V DC to the robot tool flange must be shut off when installing or servicing the gripper. This can be done from the robot main switch or from a predefined I/O signal that controls the power to the tool flange.
- Air supply to the robot must be shut off when installing or servicing the gripper.
- Make sure that all bolts have been tightened before starting any operation after maintenance work.
- Make sure that no foreign material is lying on the IRB 14000 gripper before starting an operation.
- Damaged or broken equipment can result in a safety risk.

### 1.2.2 Safety risks related to tools/work pieces

---

#### Safe handling

The IRB 14000 gripper is designed to allow manual release and removal of gripped work pieces. Both servo and vacuum modules can be overridden by manual force. If end tools (such as fingers and suction tools) and work pieces are not correctly designed and chosen, gravity or robot acceleration may cause a work piece held by the gripper to drop during motion. The work pieces must meet the weight requirements, and the end tools must be suitably designed to grip the work pieces.

#### Safe design

The IRB 14000 is intended for collaborative applications, where occasional contacts between the robot and operators is safe. End tools (such as fingers and suction tools), as well as work pieces handled by the robot, must be designed and chosen so that such contacts does not introduce safety hazards.

The IRB 14000 gripper is not designed to retain work pieces in case of power loss. Objects held by the servo and vacuum modules may be released, in the event of pneumatic or electric power loss to the gripper. The work pieces handled by the robot, as well as the collaborative work station where the robot operates, should be chosen and designed so that such release does not introduce safety hazards.

All end tools and work pieces must be included in the risk assessment by the system integrator.

# 1 Safety

---

## 1.2.3 Risks associated with live electric parts

### 1.2.3 Risks associated with live electric parts

---

#### Voltage related risks

The IRB 14000 gripper is powered by 24 V DC from the robot tool flange. A risk for short-circuit and sparks exists. All installation and service works should be done with power disconnected from the gripper and the tool flange. This can be done from the robot main switch or from a predefined I/O signal that controls the power to the tool flange. Service works shall, whenever possible, be done with the gripper mechanically removed from the robot arm.

All work must be performed by qualified personnel.

# 2 Installation and commissioning

## 2.1 Introduction

### General

This chapter contains information for installing the IRB 14000 gripper at the working site.

More detailed technical data about the gripper can be found in the *Product specification* for the robot.

### Safety information

Before any installation work is conducted, it is extremely important that all safety information is observed!

There are general safety aspects that must be read through, as well as more specific safety information that describes the danger and safety risks when performing the procedures. Read the chapter [Safety on page 13](#) before performing any installation work.



#### Note

If the robot where the gripper shall be mounted is connected to power, always ensure that the robot is connected to protective earth before starting any installation work.

For more information, see *Product manual* for the robot.

## 2 Installation and commissioning

### 2.2.1 Pre-installation procedure

## 2.2 Unpacking

### 2.2.1 Pre-installation procedure

#### Introduction

This section describes the unpacking and installation of the IRB 14000 gripper for the first time. It also covers re-installation of the IRB 14000 gripper.

#### Packing, gripper

The IRB 14000 gripper is packed following the standards of sea transportation, land transportation and air transportation on delivery.

Check the following item list in the standard delivery package before proceeding with the installation of the gripper.

No	Item	Description
1	Servo module	For the Servo option
2	Servo module + one vacuum module	For the Servo + Vacuum 1 option
3	Servo module + two vacuum modules	For the servo + Vacuum 1 + Vacuum 2 option
4	Servo module + one vision module	For the servo + Vision option
5	Servo module + one vision module +one vacuum module	For the servo + Vacuum 1 + Vision option
6	Getting-started fingers	For all options
7	Suction tools	Delivered together only with items 2, 3, or 5
8	Screw package	For all options

#### Checking the pre-requisites for installation

Installation personnel working with the IRB 14000 gripper must:

- be trained by ABB and have the required knowledge of mechanical and electrical installation/maintenance/repair work
- conform to all national and local codes.

	Action
1	Visually inspect the grippers to make sure that they are not damaged.
2	If the grippers are not installed directly, they must be stored as described in: <ul style="list-style-type: none"><li>• <a href="#">Storage conditions, gripper on page 20</a></li></ul>
3	Make sure that the expected operating environment of the grippers conforms to the specifications as described in: <ul style="list-style-type: none"><li>• <a href="#">Operating conditions, gripper on page 20</a></li></ul>
4	Before taking the grippers to the installation site, make sure that the site conforms to: <ul style="list-style-type: none"><li>• <a href="#">Protection classes, gripper on page 20</a></li><li>• <a href="#">Requirements, robot tool flange on page 20</a></li></ul>
5	When these prerequisites are met, the grippers can be taken to the installation site as described in section: <ul style="list-style-type: none"><li>• <a href="#">On-site installation on page 33</a></li></ul>

*Continues on next page*

## 2 Installation and commissioning

---

### 2.2.1 Pre-installation procedure

*Continued*

	Action
6	Install required equipment, if any.

## 2 Installation and commissioning

---

### 2.2.2 Requirements

### 2.2.2 Requirements

---

#### Requirements, robot tool flange

Make sure the area around the robot wrist has no particles that would obstruct the installation of the IRB 14000 gripper or be dangerous to the operator.

---

#### Storage conditions, gripper

The table shows the allowed storage conditions for the gripper:

Parameter	Value
Minimum ambient temperature	-20 °C
Maximum ambient temperature	+45 °C
Maximum ambient temperature (less than 24 hrs)	+55 °C
Maximum ambient humidity	85% at constant temperature (gaseous only)

---

#### Operating conditions, gripper

The table shows the allowed operating conditions for the gripper:

Parameter	Value
Minimum ambient temperature	+5 °C
Maximum ambient temperature	+45 °C
Maximum ambient humidity	85% at constant temperature (gaseous only)

---

#### Protection classes, gripper

The table shows the available protection types of the gripper, with the corresponding protection class.

Protection type	Protection class
Gripper, protection type Standard	IP30

---

#### Food contact

The gripper is not intended to be in contact with food.

---

#### Sterile environments

The gripper is not intended to be operated in sterile environments.

---



## 2.3 Technical data

### 2.3.1 General

#### Weight and load capacity

Combination	Weight (g) without fingers, suction cup(s), and filter(s) <sup>i</sup>	Weight (g) of the whole gripper	Max. load capacity (g) without fingers, suction cup(s), and filter(s) <sup>ii</sup>	Max. load capacity (g) of the whole gripper <sup>ii</sup>
Servo	215	230	285	270
Servo + Vacuum 1	225.5	248	274.5	252
Servo + Vacuum 1 + Vacuum 2	250	280	250	220
Servo + Vision	229	244	271	256
Servo + Vision + Vacuum 1	239.5	262	260.5	238

<sup>i</sup> The getting-started fingers weighs 15 gram, and the standard suction cups and filters weighs 7.5 gram per set.

<sup>ii</sup> Load capacity = 500 - weight  
Center of gravity (CoG) limitations applied. See the load diagram for the robot.

#### Detailed mass data - Center of Gravity

Combination	CoG (mm) without fingers, suction cup(s), and filter(s)			CoG (mm) of the whole gripper		
	x	y	z	x	y	z
Servo	8.7	12.3	49.2	8.2	11.7	52
Servo + Vacuum 1	8.9	12.3	48.7	8.6	11.7	52.7
Servo + Vacuum 1 + Vacuum 2	7.4	12.4	44.8	7.1	11.9	47.3
Servo + Vision	7.9	12.4	48.7	7.5	11.8	52.7
Servo + Vision + Vacuum 1	8.2	12.5	48.1	7.8	11.9	50.7

#### Detailed mass data - Inertia

Combination	Inertia (kgm <sup>2</sup> ) without fingers, suction cup(s), and filter(s)			Inertia (kgm <sup>2</sup> ) of the whole gripper		
	lxx	lyy	lzz	lxx	lyy	lzz
Servo	0.00017	0.00020	0.00008	0.00021	0.00024	0.00009
Servo + Vacuum	0.00017	0.00020	0.00008	0.00021	0.00024	0.00009
Servo + Vacuum 1 + Vacuum 2	0.00020	0.00024	0.00011	0.00025	0.00029	0.00012
Servo + Vision	0.00017	0.00019	0.00008	0.00021	0.00023	0.00008

*Continues on next page*

## 2 Installation and commissioning

### 2.3.1 General

Continued

Combination	Inertia (kgm <sup>2</sup> ) without fingers, suction cup(s), and filter(s)			Inertia (kgm <sup>2</sup> ) of the whole gripper		
	lxx	lyy	lzz	lxx	lyy	lzz
Servo + Vision + Vacuum	0.00018	0.00020	0.00009	0.00022	0.00024	0.00009

#### Tooldata definitions without fingers, suction cup(s), and filter(s)

Combination	Tooldata
Servo	[ TRUE, [ [0, 0, 0], [1, 0, 0, 0] ], [0.215, [8.7, 12.3, 49.2], [1, 0, 0, 0], 0.00017, 0.00020, 0.00008] ]
Servo + Vacuum	[ TRUE, [ [0, 0, 0], [1, 0, 0, 0] ], [0.226, [8.9, 12.3, 48.7], [1, 0, 0, 0], 0.00017, 0.00020, 0.00008] ]
Servo + Vacuum 1 + Vacuum 2	[ TRUE, [ [0, 0, 0], [1, 0, 0, 0] ], [0.250, [7.4, 12.4, 44.8], [1, 0, 0, 0], 0.00020, 0.00024, 0.00011] ]
Servo + Vision	[ TRUE, [ [0, 0, 0], [1, 0, 0, 0] ], [0.229, [7.9, 12.4, 48.7], [1, 0, 0, 0], 0.00017, 0.00019, 0.00008] ]
Servo + Vision + Vacuum	[ TRUE, [ [0, 0, 0], [1, 0, 0, 0] ], [0.240, [8.2, 12.5, 48.1], [1, 0, 0, 0], 0.00018, 0.00020, 0.00009] ]

#### Tooldata definitions with fingers, suction cup(s), and filter(s)

Combination	Tooldata
Servo	[ TRUE, [ [0, 0, 0], [1, 0, 0, 0] ], [0.230, [8.2, 11.7, 52.0], [1, 0, 0, 0], 0.00021, 0.00024, 0.00009] ]
Servo + Vacuum	[ TRUE, [ [0, 0, 0], [1, 0, 0, 0] ], [0.248, [8.6, 11.7, 52.7], [1, 0, 0, 0], 0.00021, 0.00024, 0.00009] ]
Servo + Vacuum 1 + Vacuum 2	[ TRUE, [ [0, 0, 0], [1, 0, 0, 0] ], [0.280, [7.1, 11.9, 47.3], [1, 0, 0, 0], 0.00025, 0.00029, 0.00012] ]
Servo + Vision	[ TRUE, [ [0, 0, 0], [1, 0, 0, 0] ], [0.244, [7.5, 11.8, 52.7], [1, 0, 0, 0], 0.00021, 0.00023, 0.00008] ]
Servo + Vision + Vacuum	[ TRUE, [ [0, 0, 0], [1, 0, 0, 0] ], [0.262, [7.8, 11.9, 50.7], [1, 0, 0, 0], 0.00022, 0.00024, 0.00009] ]

Continues on next page

### Mass data, illustration

The following figure shows the mass data of the gripper with one servo module and one vacuum module as an example.

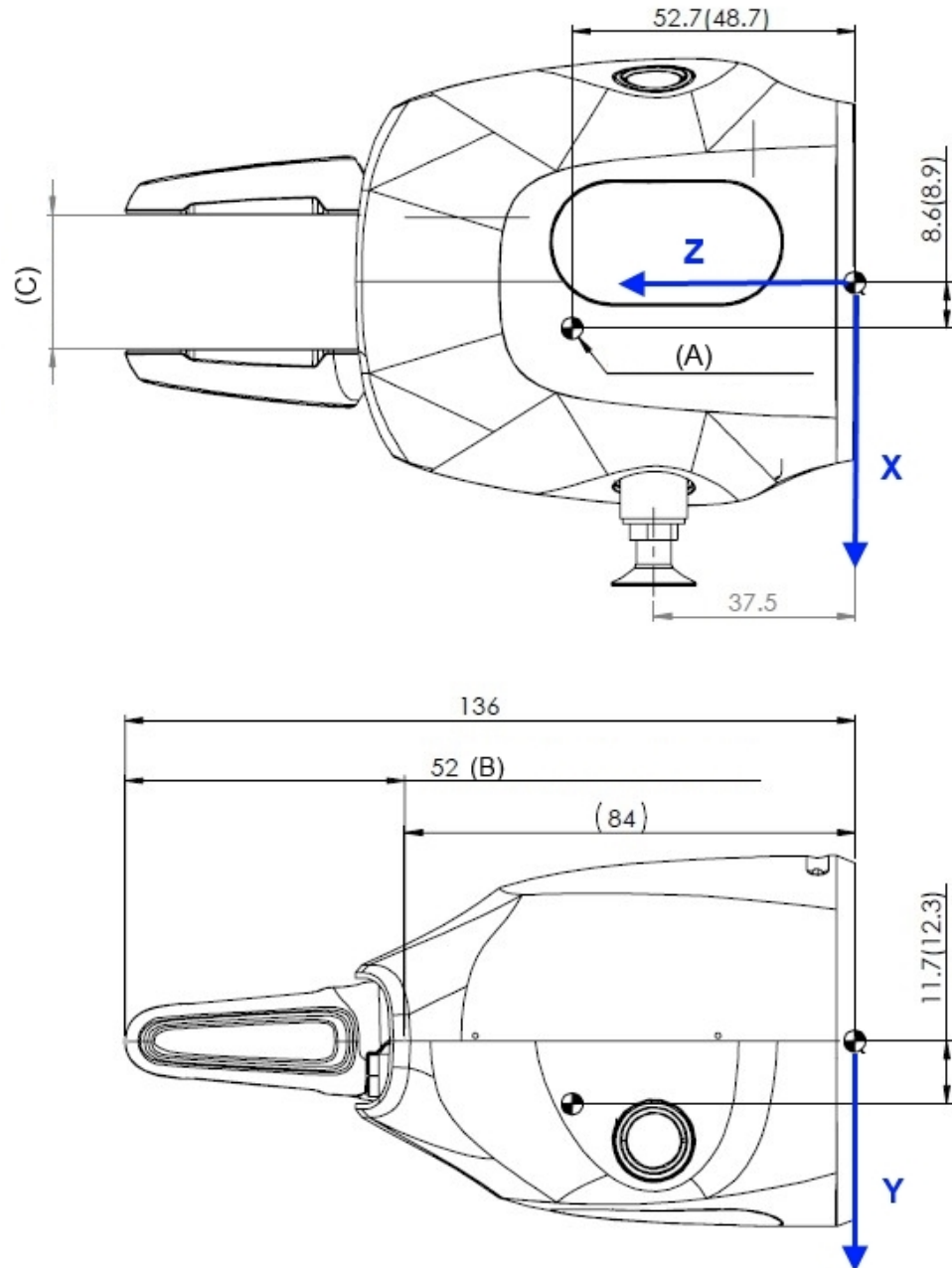

xx150000826

A	CoG Note: Dimensions of CoG in the brackets are without the fingers and suction tools
B	Getting-started finger length
C	Travel length: 0-50 mm

Continues on next page

## 2 Installation and commissioning

### 2.3.1 General

*Continued*

#### Airborne noise level

Description	Note
The sound pressure level outside	< 55 dB, measured at a location 0.5 m away from the gripper.

#### Power consumption

The gripper is powered by 24 V DC and the maximum power consumption of the whole gripper is 9 W.

#### Air consumption

Maximum air consumption is 15 liters/minute for a single pneumatic module.

#### Dimensions

The following figure shows the dimension of the gripper with one servo module and two vacuum modules. The dimensions of other gripper options can be obtained by simply removing the dimension data of the suction cups and filters. For the specific dimension of the camera used in the gripper with a vision module, see [Camera, dimensions on page 29](#).

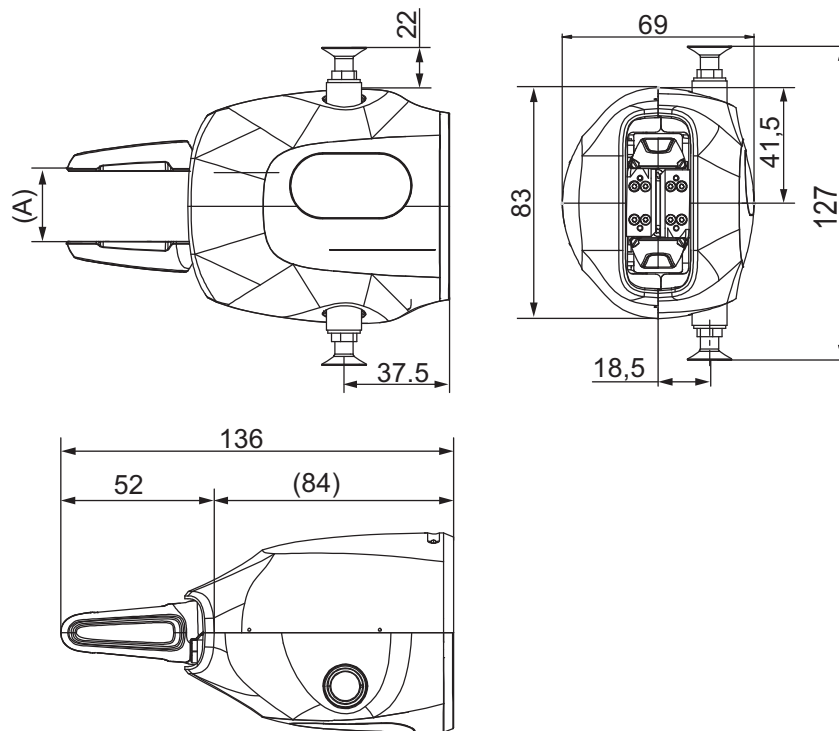

xx1500000106

Pos	Description
A	Travel length = 0-50 mm

## 2.3.2 Servo module

### Travel length

Description	Data
Travel length	0-50 mm (max. 25 mm per finger)

### Maximum speed

Description	Data
Speed	25 mm/s
Repeatability	±0.05 mm

### Gripping force

Description	Data
Gripping direction	Inward or outward
Maximum gripping force	20 N (at the gripping point of 40 mm) <sup>i</sup>
External force (not in gripping directions)	15 N (at the gripping point of 40 mm)
Force control accuracy	±3 N

<sup>i</sup> The gripping times of getting-started fingers is 10,000 under the maximum gripping force 20 N.

### Load diagram

The following figures show the relationship between the maximum allowed gripping force and gripping point to the finger flange.

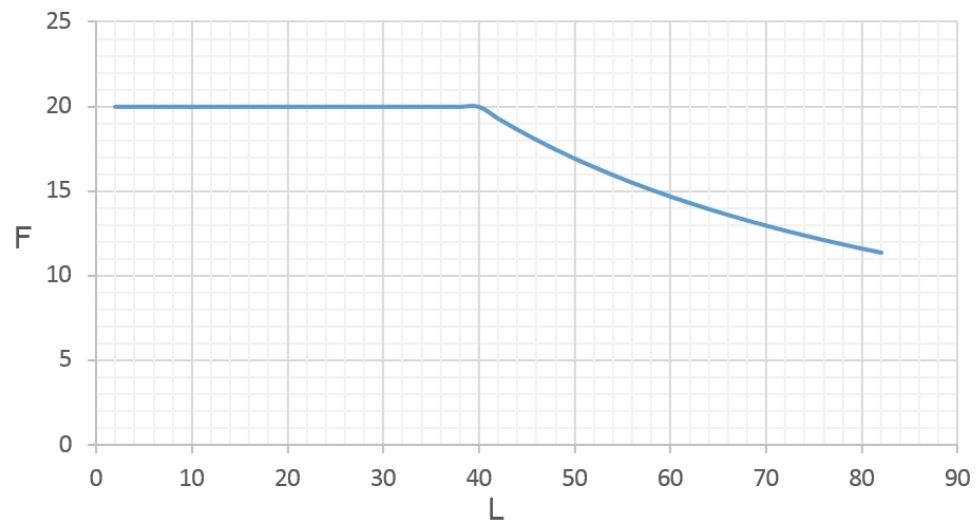

xx1500000792

*Continues on next page*

## 2 Installation and commissioning

### 2.3.2 Servo module

Continued

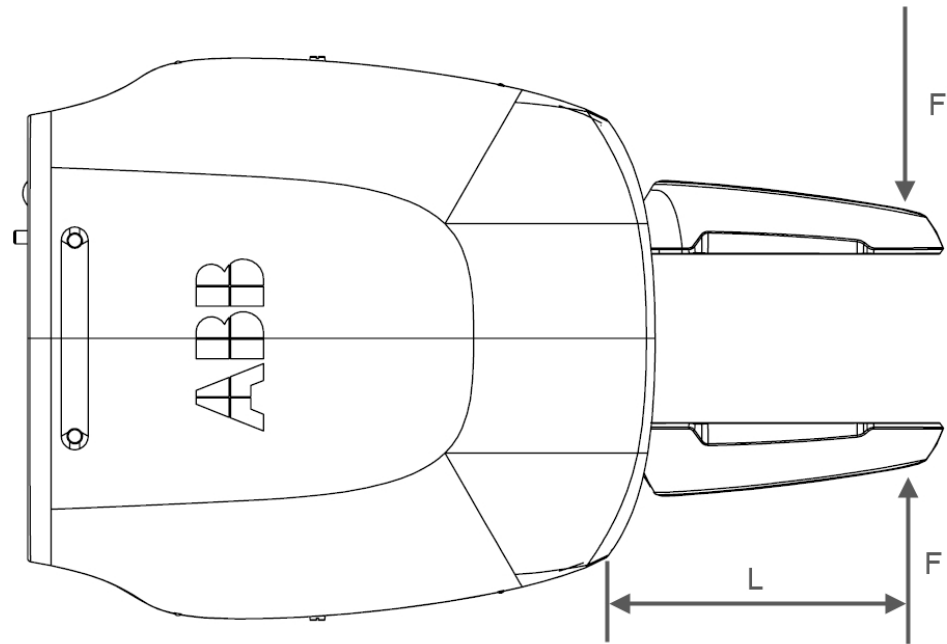

xx150000797

Pos	Description
F	Gripping force, in unit of N
L	Length from the gripping point to the finger flange, in unit of mm

The following figures show the relationship between the maximum allowed external force and gripping point to the finger flange.

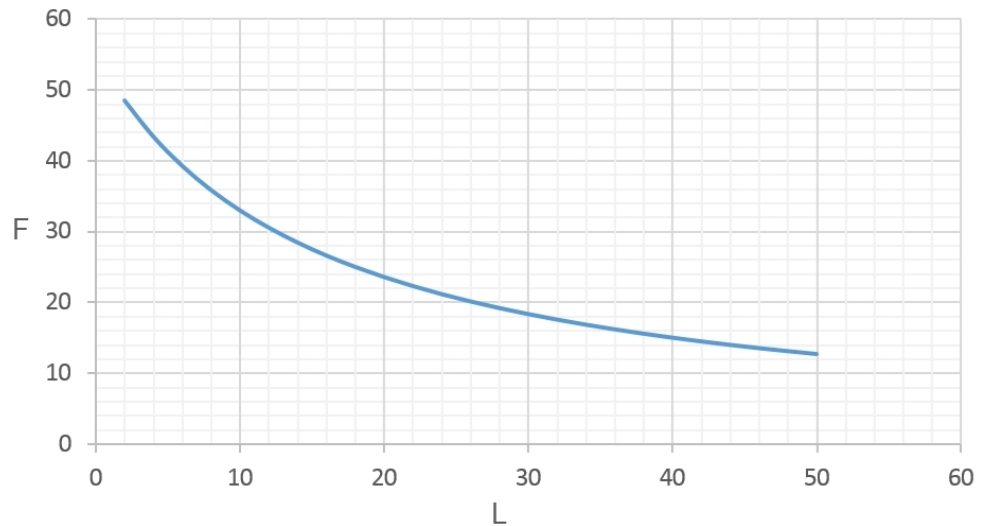

xx150000798

Continues on next page

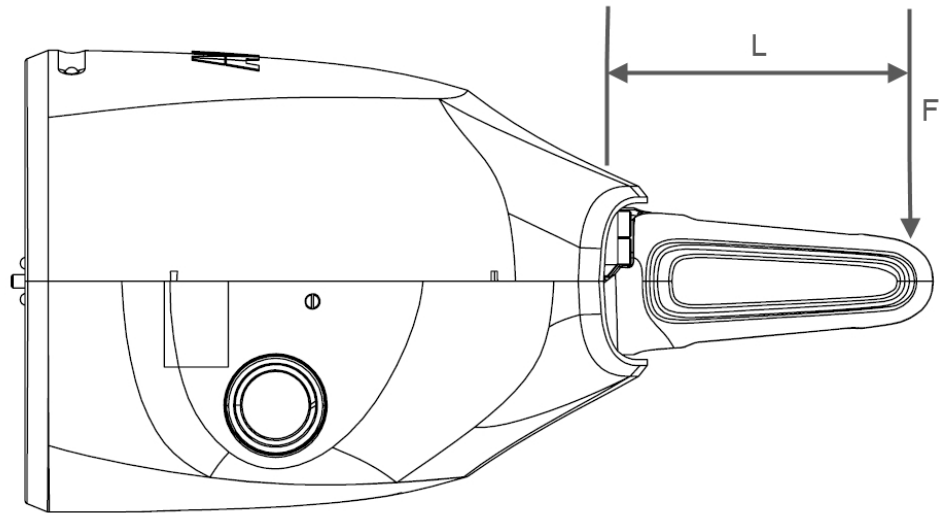

xx150000799

Pos	Description
F	External force, in unit of N
L	Length from the gripping point to the finger flange, in unit of mm

#### Position control and calibration

The servo module has integrated position control with the repeatability of  $\pm 0.05$  mm. The servo module is calibrated by RAPID instructions or using the FlexPendant interface. For details, see the section [IRB 14000 gripper FlexPendant application on page 44](#) and chapter [RAPID references on page 115](#).

## 2 Installation and commissioning

---

### 2.3.3 Vacuum module

### 2.3.3 Vacuum module

---

#### Vacuum generator

The vacuum module has an integrated vacuum generator that is designed with a maximum payload of 150 g. The actual payload capacity depends on the following factors:

- Suction tool design and the choice of suction cups
- The surface structure of the object being picked
- The pickup point and the CoG of the object being picked
- Robot motion while the object is picked
- Air pressure input to the robot

---

#### Vacuum pressure sensor

The air pressure of the vacuum module can be monitored in real time using an in-built vacuum sensor. This makes it possible to detect whether the object is correctly picked up by the suction tool.

---

#### Blow-off actuator

To minimize cycle time and ensure accurate drop-off of the picked objects, a blow-off actuator is integrated in the vacuum module.



2.3.4 Vision module

General

The vision module includes a Cognex AE3 camera and provides powerful and reliable vision and identification tools.

Camera, specification

Description	Data
Resolution	1.3 Megapixel
Lens	6.2 mm f/5
Illumination	Integrated LED with programmable intensity
Software engine	Powered by Cognex In-Sight
Application programming software	ABB Integrated vision or Cognex In-Sight Explorer

Camera, dimensions

The following figure shows the dimension of the Cognex AE3 camera.

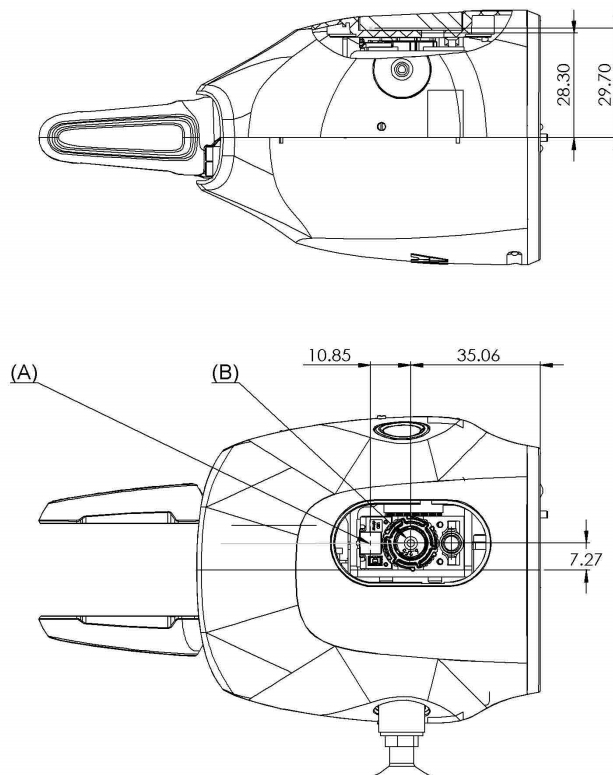

xx1500001395

Pos	Description
A	Internal illumination

*Continues on next page*

## 2 Installation and commissioning

### 2.3.4 Vision module

Continued

Pos	Description
B	Lens

#### Lens focusing

Use the following procedure to focus the lens of the Cognex AE3 camera.

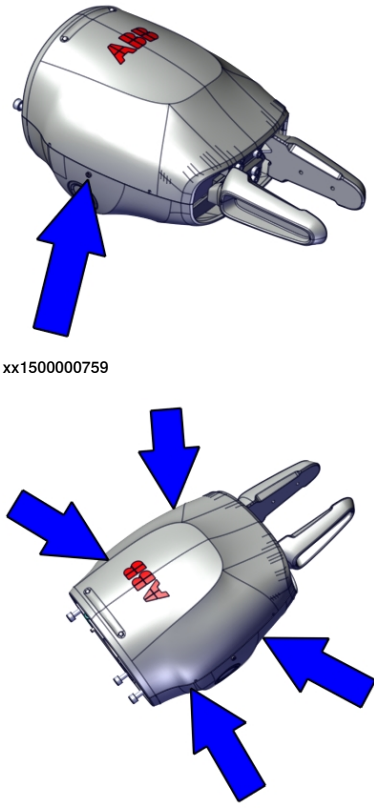
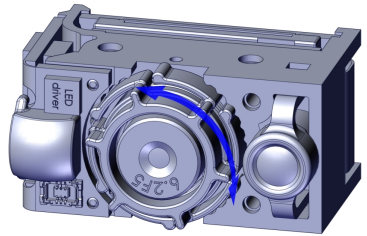
	Action	Note
1	For the gripper also with a vacuum module, twist and remove the filter and suction cup first.	
2	Remove the screws that fasten the shell, and then press the shell sides gently to detach the shell. The shell consists of two parts: <ul style="list-style-type: none"> <li>• lower shell</li> <li>• upper shell</li> </ul>	 <p>xx150000759</p> <p>xx1400002152</p>
3	Rotate the focusing ring of the 6.2 mm lens to fit the application.	 <p>xx1500001621</p>

Continues on next page

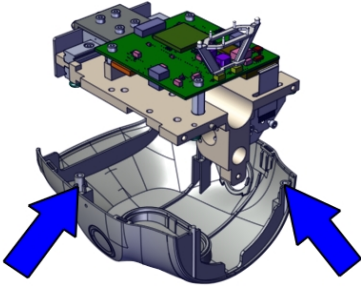
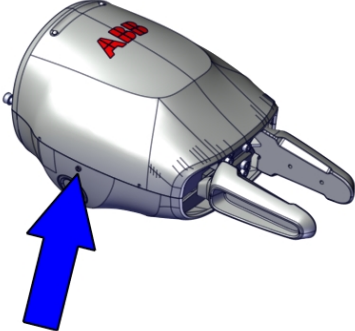
	Action	Note
4	Put the shell to the base plate by locating the location pins to the location holes on the base plate. Press the two shell parts together. Then, refit the two M1.2 screws.	 <p data-bbox="1059 680 1166 696">xx1400002155</p>  <p data-bbox="1059 1099 1166 1115">xx1500000759</p>
5	For the gripper also with a vacuum module, refit the filter and suction cup by twisting them.	

## 2 Installation and commissioning

### 2.3.5 Fingers

### 2.3.5 Fingers

#### Getting-started finger, dimensions

The following figure shows the dimension of the getting-started finger.

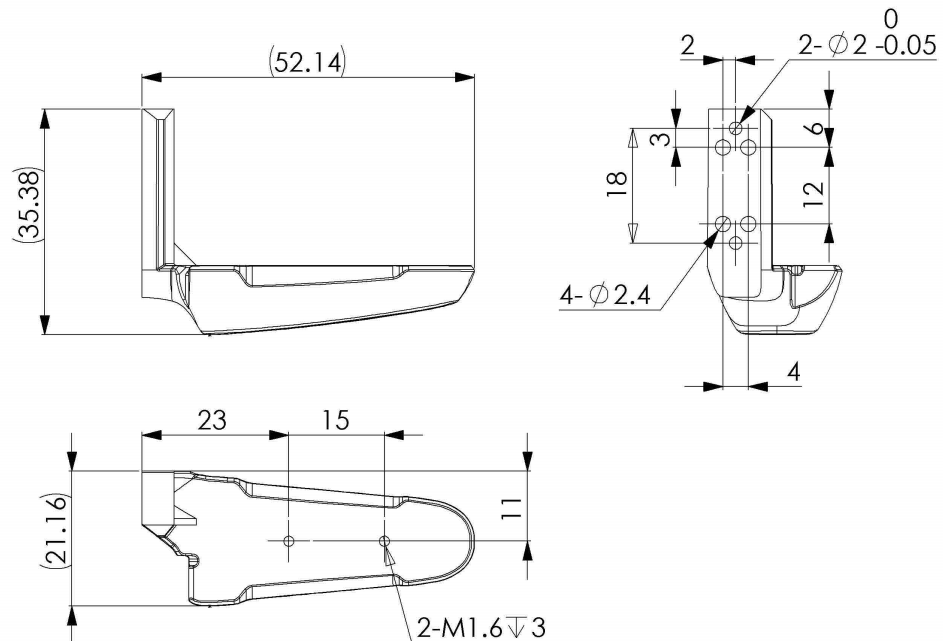

xx1500001606

#### Design requirements for customized fingers

Except for the two getting-started fingers delivered together with the IRB 14000 gripper, it is also possible for users to customize fingers based on actual requirements. The getting-started fingers can grip only up to 10,000 times under the maximum gripper force 20 N; therefore, it is always recommended customized fingers be designed and used.

When designing fingers, the following requirements should be met:

- To enhance the stiffness for gripping and extend lifetime of the fingers, it is recommended that metal is being used as the finger materials.
- The finger size must be designed properly to prevent any collision with the gripper shell during the finger movement or gripping.
- The length of the screws that are used for fastening the fingers to the finger flange must be proper and less than the maximum hole depth on the flange. For details about the maximum hole depth, see [Hole configuration, finger flange on page 41](#).
- Installation direction and position of the fingers should follow those of the getting-started fingers. For details, see [Getting-started finger, dimensions on page 32](#).

## 2.4 On-site installation

### 2.4.1 Air and power supply

---

#### Requirements

The IRB 14000 gripper is supplied with air and 24 V DC power from the IRB 14000 tool flange.

Before installing the gripper, ensure that air and electric power supply to the tool flange is shut off. The electric power can be shut off from the robot main switch or from a predefined I/O signal that controls power to the tool flange. The air supply cannot be controlled from within the robot, or from the robot main switch, and has to be shut off externally.

The air supply to the robot should be 5.5-6 bar, filtered and non-lubricated. The nominal operating pressure is 6 bar.

Before any installation or service work on the gripper, ensure that the safety instructions in section [Safety on page 13](#) are followed.

## 2 Installation and commissioning

---

### 2.4.2 Recommended standard tightening torque

### 2.4.2 Recommended standard tightening torque

---

#### Standard tightening torque

The table below specifies the recommended standard tightening torque for the screws.

Screw type	Tightening torque (Nm) on metal	Tightening torque (Nm) on plastic
M1.2	N/A	0.05
M1.6 (12.9 class carbon steel screw)	0.25	N/A
M1.6 (stainless steel screw)	N/A	0.05
M2	0.25	0.1
M2.5	0.45	0.45

### 2.4.3 Mounting the gripper

#### Mounting flange

Three M2.5 holes and one guide pin are used to assemble the gripper to the arm tool flange.

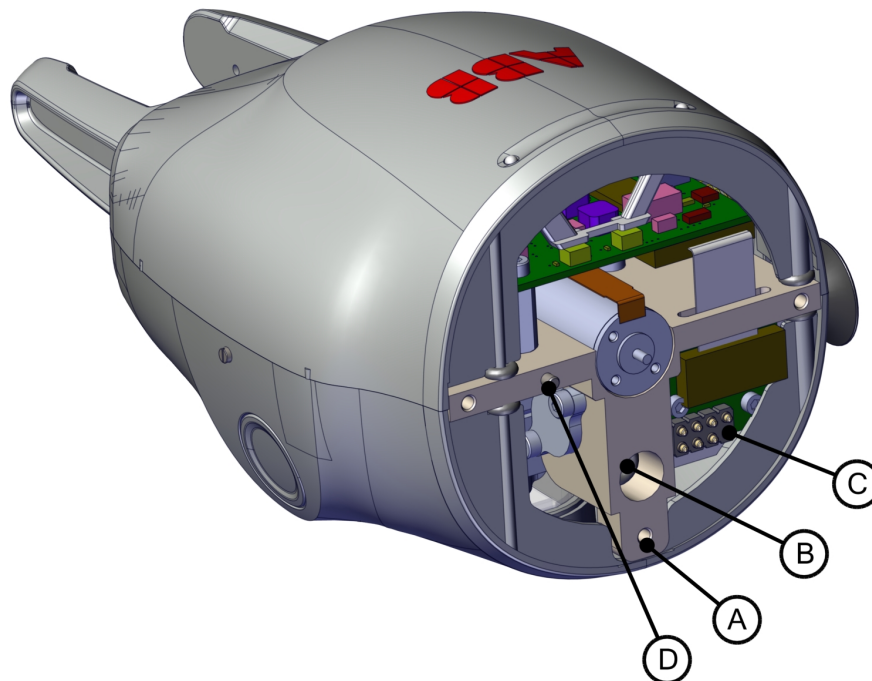

xx150000126

Pos	Description
A	Recommended screws, three M2.5 x 8
B	Air hose
C	8-pin connector (spring-loaded)
D	Guide pin

*Continues on next page*

## 2 Installation and commissioning

### 2.4.3 Mounting the gripper

*Continued*

The pins of the connector (shown as C in the preceding figure) are defined as follows.

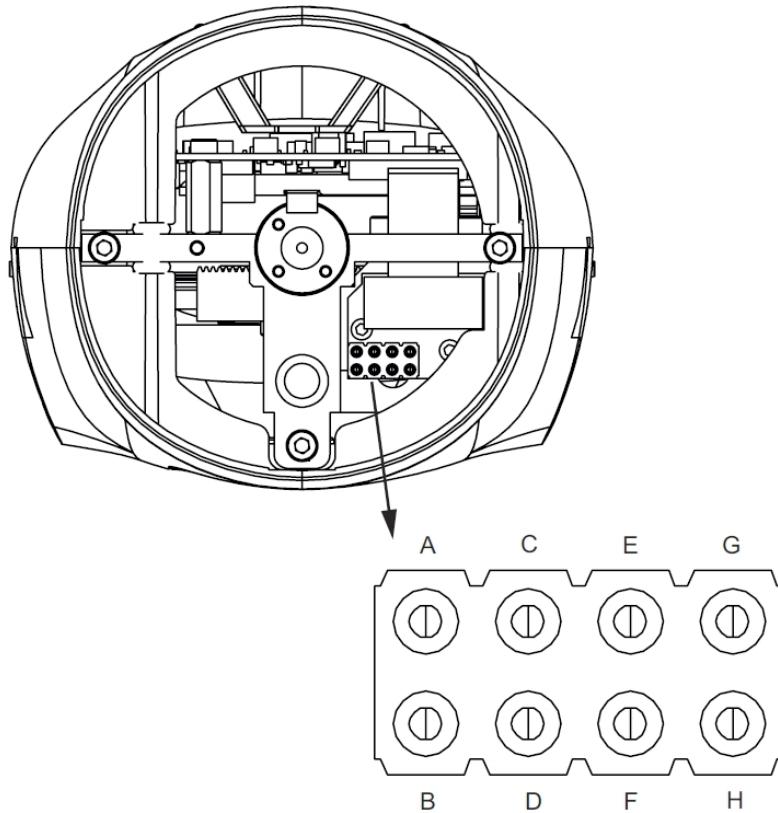

xx1500000796

Pin	Description
A	EtherNet RD-
B	EtherNet TD-
C	EtherNet RD+
D	EtherNet TD+
E	PE
F	Spare
G	0V, IO
H	24V, IO

*Continues on next page*



#### Hole configuration, mounting base

The following figure shows the hole configuration when assembling the gripper to the arm tool flange.

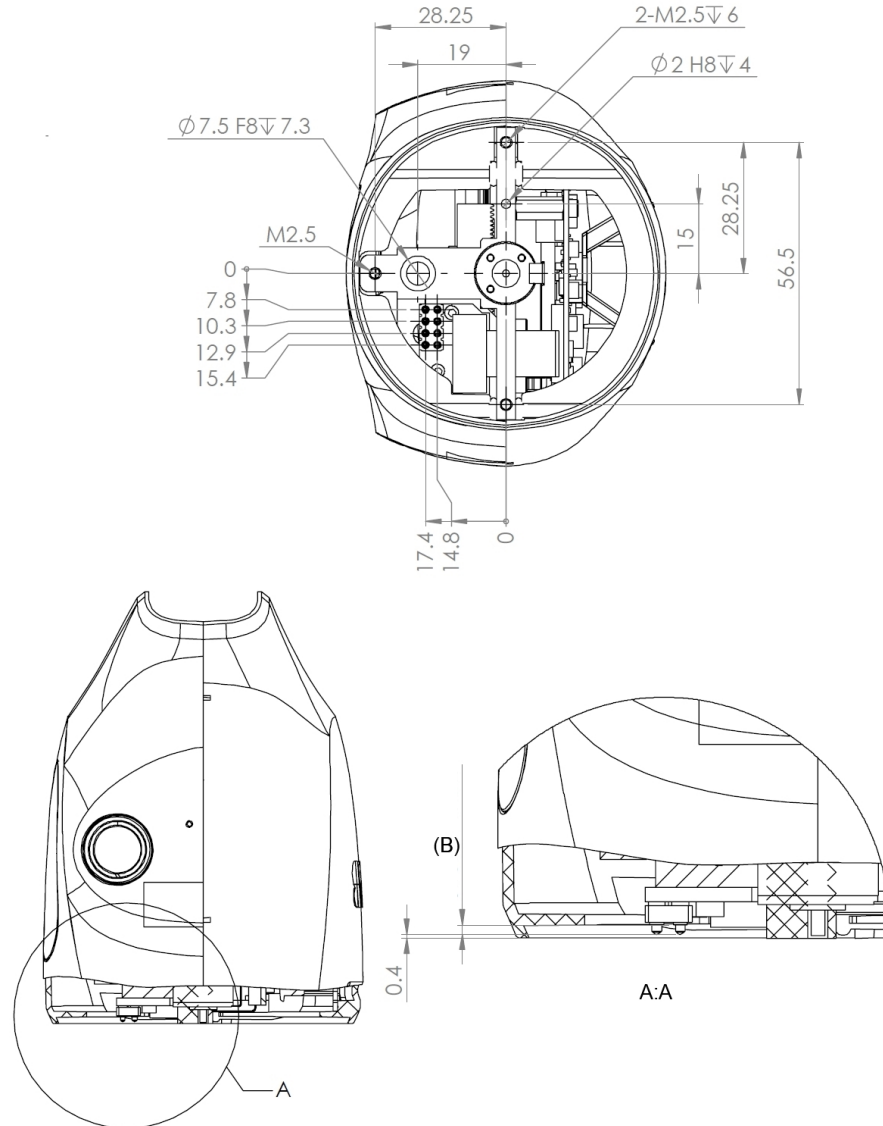

xx1500000793

Pos	Description
B	Stroke = 1 mm

#### Installing the gripper

##### Required tools and equipment

Equipment	Article number	Note
Standard toolkit	-	Content is defined in section <a href="#">Standard toolkit on page 155</a> .

Continues on next page

## 2 Installation and commissioning

### 2.4.3 Mounting the gripper

Continued

#### Required spare part

Spare part	Part No.	Note
SERVO	3HAC054831-001	Used when the Servo gripper is chosen.
SERVO + VISION	3HAC054832-001	Used when the Servo + Vision gripper is chosen.
SERVO + VACUUM 1	3HAC054833-001	Used when the Servo + Vacuum 1 gripper is chosen.
SERVO + VACUUM 1 + VISION	3HAC054834-001	Used when the Servo + Vision + Vacuum 1 gripper is chosen.
SERVO + VACUUM 1 + VACUUM 2	3HAC054835-001	Used when the Servo + Vacuum 1 + Vacuum 2 gripper is chosen.

#### Procedure

Use the following procedure to install a whole gripper onto the robot arm.

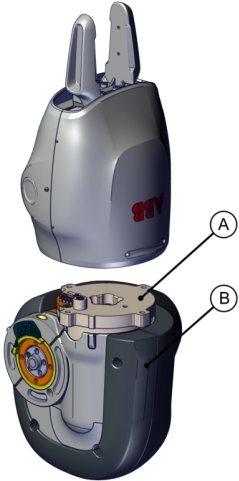
	Action	Note
1	 <b>CAUTION</b> Do not install or remove the gripper when power is on. Otherwise damage to the electronics may occur. Always check the gripper power status before commencing any service work. Make sure that all supplies for electrical power and air pressure are turned off.	For details about how to check the power status and how to turn off gripper power using FlexPendant, see <a href="#">Configuration page on page 48</a> .
2	Position the gripper to the arm tool flange on the axis 6 of the robot.	 <p>xx1500001394</p> <p>A Arm tool flange B Axis 6 of the robot</p>
3	Use the guide pin and air hose hole to make the gripper align with the arm tool flange.	For the positions of the guide pin and air hose hole, see <a href="#">Mounting flange on page 35</a> .

Continues on next page

## 2 Installation and commissioning

### 2.4.3 Mounting the gripper Continued

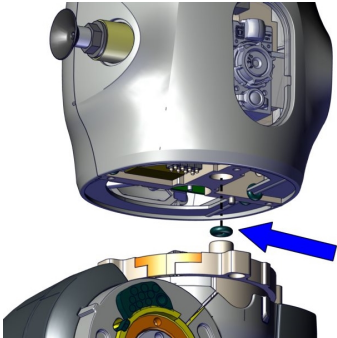
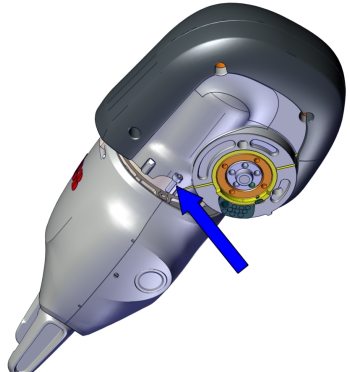
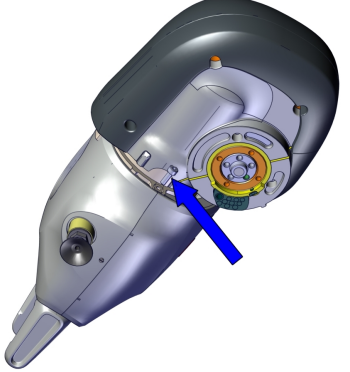
	Action	Note
4	For the gripper with a vacuum module, fit an O-ring in the air hose hole.	O-ring 4x2: 3HAC063220-001 (1 pcs)  xx1500001625
5	Rotate the arm tool flange with the gripper to make one of the three screw holes accessible and then refit the screw.	Screw: M2.5x8, 3HAC051701-001 (1 pcs)  xx1500001391
6	Rotate the flange with 180 degrees to access the opposite screw hole and then refit the screw.	Screw: M2.5x8, 3HAC051701-001 (1 pcs)  xx1500001392

Continues on next page

## 2 Installation and commissioning

### 2.4.3 Mounting the gripper

Continued

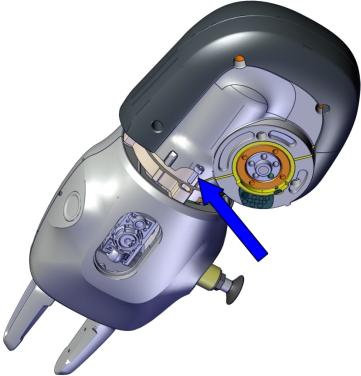
	Action	Note
7	Rotate the flange with 90 degrees to access the last screw hole and then refit the screw.	Screw: M2.5x8, 3HAC051701-001 (1 pcs)  xx1500001393
8	Turn on the power and air supply to the gripper and then perform commissioning on the gripper.	

2.4.4 Mounting the fingers

General

A pair of getting-started fingers are provided together with the gripper for demo and test purposes. These fingers should be replaced with fingers designed for the actual application by the system integrator and must be included in the final risk assessment done by the system integrator.

Hole configuration, finger flange

The following figures show the hole configuration and main dimensions of the finger flanges.

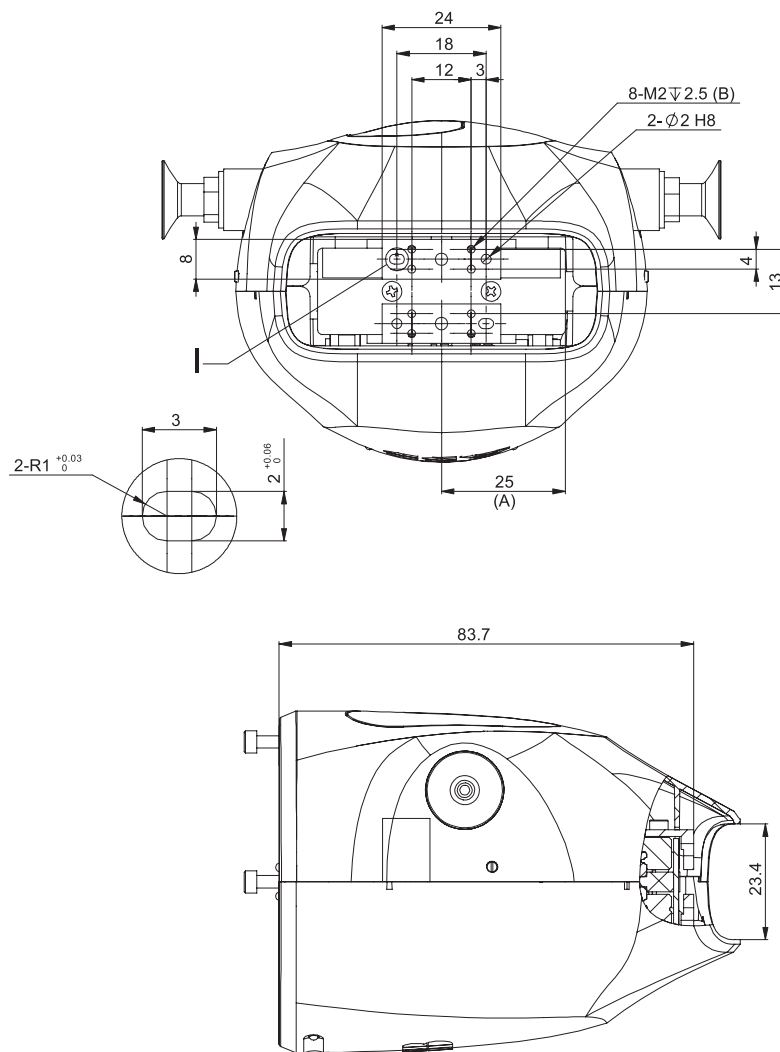

xx150000794

Pos	Description
A	Position of the maximum displacement
B	Maximum hole depth

## 2 Installation and commissioning

---

### 2.4.5 Mounting tools to the vacuum module

### 2.4.5 Mounting tools to the vacuum module

---

#### General

The vacuum module is delivered with a first set of suction cups and filters for demo and test purposes. Application-specific suction tools should be designed and chosen by the system integrator. Air filters are required in the suction tools to ensure the long-term performance of the vacuum module. If the vacuum function is not required, passive assembly tools, such as press tools, can also be mounted to the suction tool interface. Any tools mounted to the gripper must be included in the final risk assessment by the system integrator.

*Continues on next page*

## 2 Installation and commissioning

### 2.4.5 Mounting tools to the vacuum module

*Continued*

#### Hole configuration, vacuum tools

The following figure shows the hole configuration and tool interface of the vacuum module.

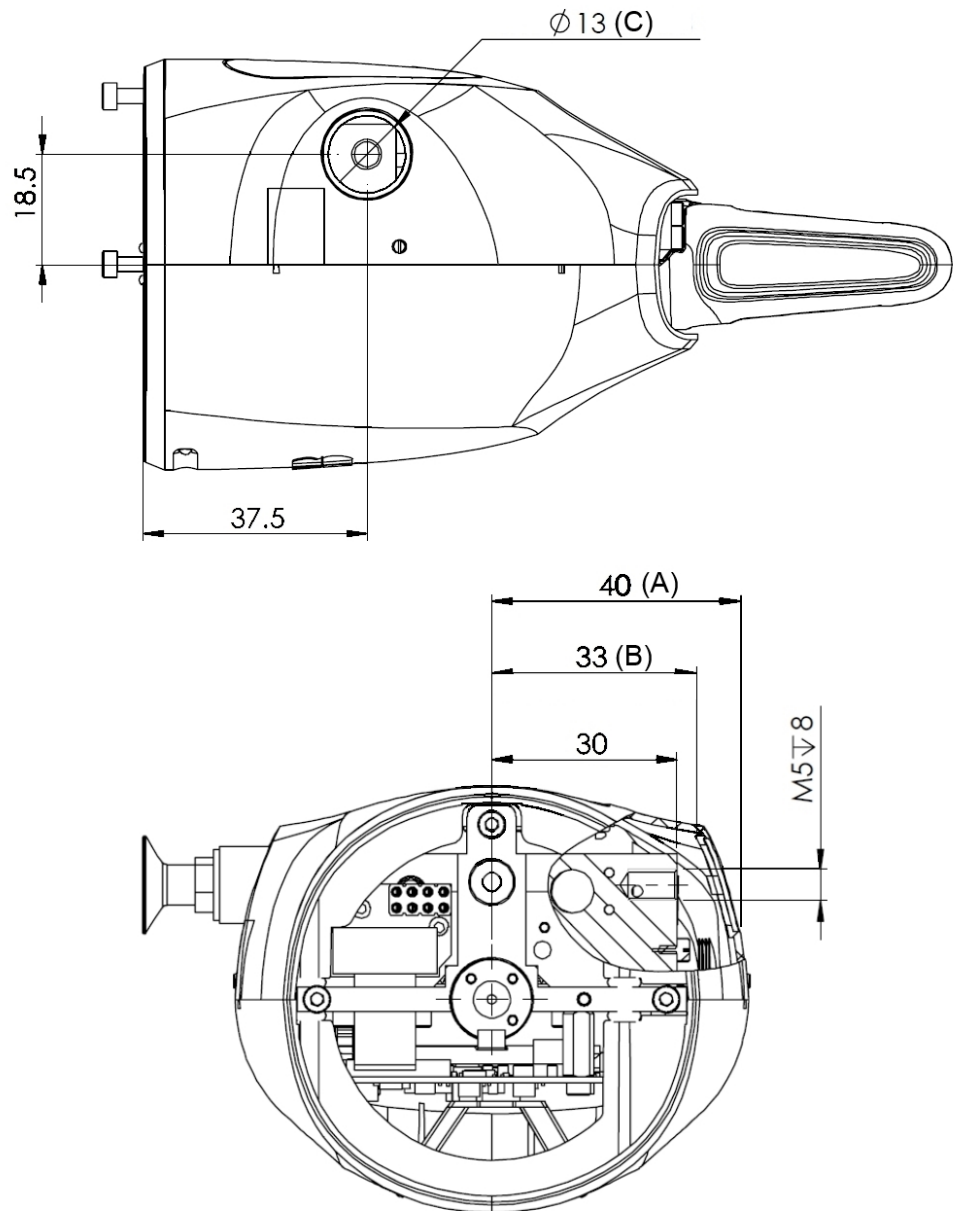

xx150000795

Pos	Description
A	Length from the center to the outer shell surface
B	Length from the center to the inner shell surface
C	Shell hole depth

## 2 Installation and commissioning

---

### 2.5 IRB 14000 gripper FlexPendant application

### 2.5 IRB 14000 gripper FlexPendant application

---

#### Overview

The following requirements must be met for the gripper configuration.

Item	Note
Options for manipulator and controller	The gripper option must be chosen.
RobotWare	<ul style="list-style-type: none"><li>• RobotWare 6.01 or later</li><li>• SmartGripper add-in</li></ul> SmartGripper add-in is a RobotWare option for ABB smart grippers. All files related to ABB smart grippers will be installed automatically, such as configuration files, RAPID driver and FlexPendant application.

*Continues on next page*



#### 2.5.1 Installing IRB 14000 gripper FlexPendant application

---

##### Installation procedure

- 1 Install the SmartGripper add-in from the **RobotStudio Add-Ins** ribbon tab. For details about how to install an add-in, see *Operating manual - RobotStudio*.
- 2 During the creating or modification of a robot system using the installation manager, select **SmartGripper Add-In** in the **Select Product** dialog box, and then select the SmartGripper add-in license in the **Licenses** page. In the **Options** page, make sure that the options *617-1 FlexPendant Interface*, *709-1 DeviceNet Master/Slave*, and *841-1 Ethernet/IP Scanner/Adapter* are selected.
- 3 Install the robot system and restart the controller.  
The **SmartGripper** icon is displayed in the ABB main menu on the FlexPendant.

## 2 Installation and commissioning

---

### 2.5.2 Updating IRB 14000 gripper FlexPendant application

### 2.5.2 Updating IRB 14000 gripper FlexPendant application

---

#### Updating procedure

- 1 Install the new SmartGripper add-in from the **RobotStudio Add-Ins** ribbon tab. For details about how to install an add-in, see *Application manual - RobotWare Add-Ins*.
- 2 Open the installation manager in RobotStudio, select the required system to update the SmartGripper add-in, and then click **Next** to proceed to the **Products** page.
- 3 Replace the old add-in with the new one.
- 4 Install the robot system and restart the controller.

The **SmartGripper** icon is displayed in the ABB main menu on the FlexPendant.

2.5.3 IRB 14000 gripper FlexPendant application GUI

Main page

The following figure shows the main page of IRB 14000 gripper FlexPendant application, which is a navigation page with the add-in version displayed at the lower right corner.

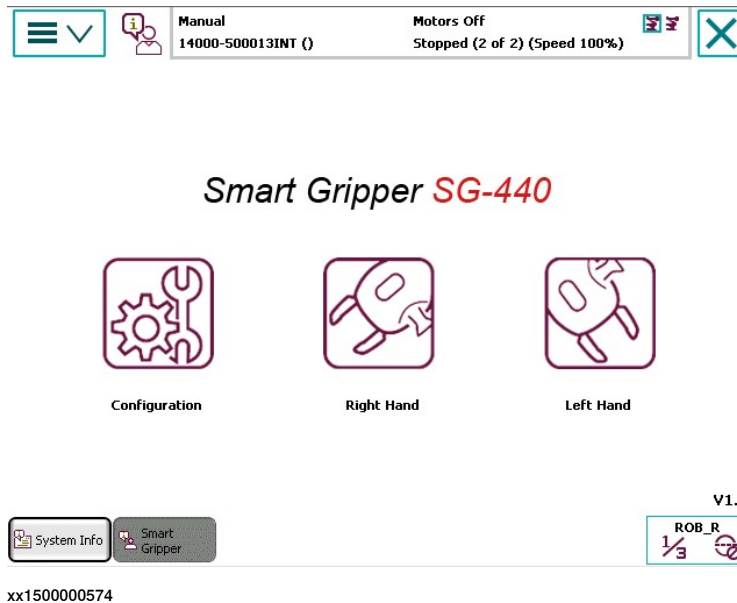

xx1500000574

If you click on the version, detailed version information about the SmartGripper add-in and related firmware, HandDriver, and EIO will be displayed as shown in the following figure.

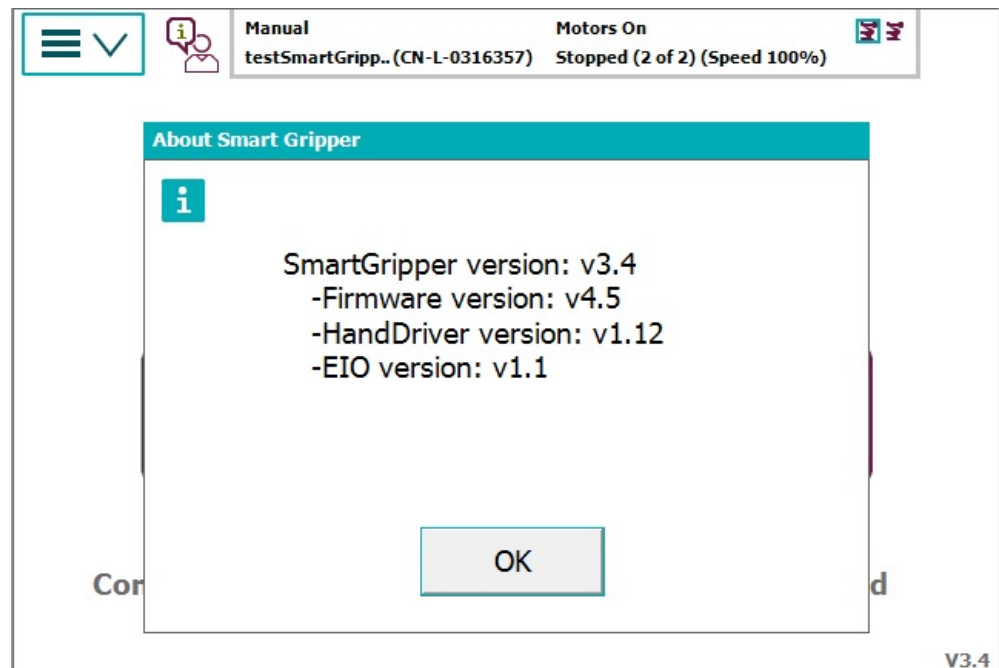

xx1600001271

Continues on next page

## 2 Installation and commissioning

### 2.5.3 IRB 14000 gripper FlexPendant application GUI

Continued

The main page is showed after starting the FlexPendant application and closing the subpages. If a gripper is connected to the robot control unit, the corresponding **Right Hand** or **Left Hand** button will be enabled.

#### Configuration page

The following figure shows the configuration page for the IRB 14000 gripper.

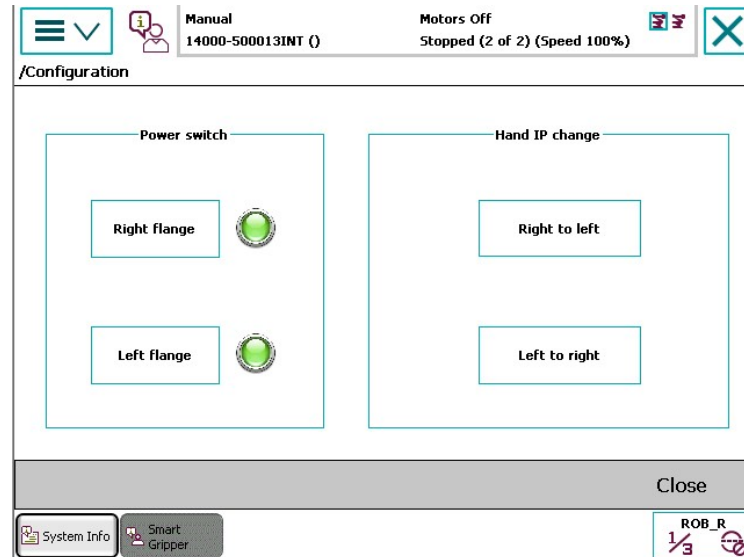

xx1500000575

In the configuration page, you can turn on or off the flange power and set up Left and Right identity of grippers.

If the flange power is on, the corresponding status led is green, otherwise, it is red.

The IRB 14000 gripper FlexPendant application uses IP addresses to distinguish the left gripper and right gripper. If a button is enabled, the corresponding gripper can successfully communicate with the robot control unit and Left and Right identity can be set up. See [Software commissioning on page 52](#).

Continues on next page

#### Servo module tab page

The following figure shows the **Servo module** tab page in the hand page, which provides operations related to gripper motion.

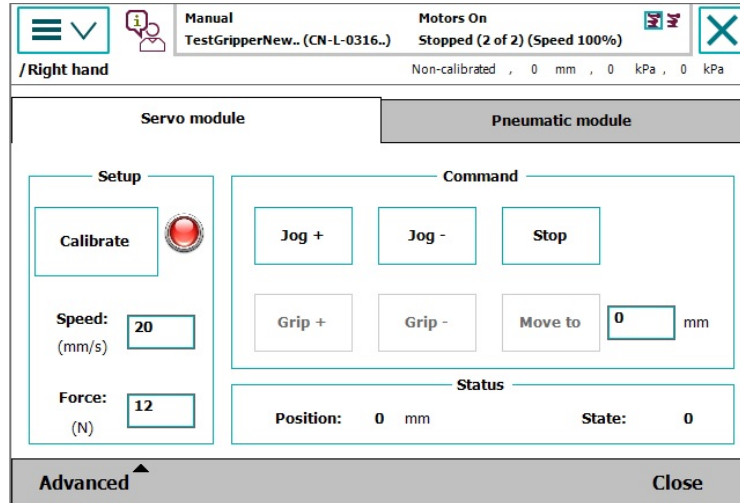

xx150000576

Three function groups are available on the **Servo module** tab page: **Setup**, **Command**, and **Status**.

Group	Parameter	Description
Setup	Calibrate	Calibrates the gripper at the current position.
	Speed	Sets the movement speed of fingers on the gripper.
	Force	Sets the gripping force of fingers on the gripper.
Command	Jog/Stop/Grip+/Grip-/Move to	If the gripper is not calibrated, only the functions <b>Jog</b> and <b>Stop</b> can be used, and the functions <b>Grip+</b> , <b>Grip-</b> and <b>Move to</b> are disabled.
Status	Position	Indicates the current position of the gripper.
	Error state	Indicates the state of the gripper. For details about the gripper states, see <a href="#">Returned value on page 143</a> .



#### Note

Tap **Advanced** > **About hand** to get the firmware version of the gripper.

*Continues on next page*

## 2 Installation and commissioning

### 2.5.3 IRB 14000 gripper FlexPendant application GUI

Continued

#### Pneumatic module tab page

The following figure shows the **Pneumatic module** tab page in the hand page, which is used for instructing the built-in valves to finish vacuum-sucking and blow-off operations.

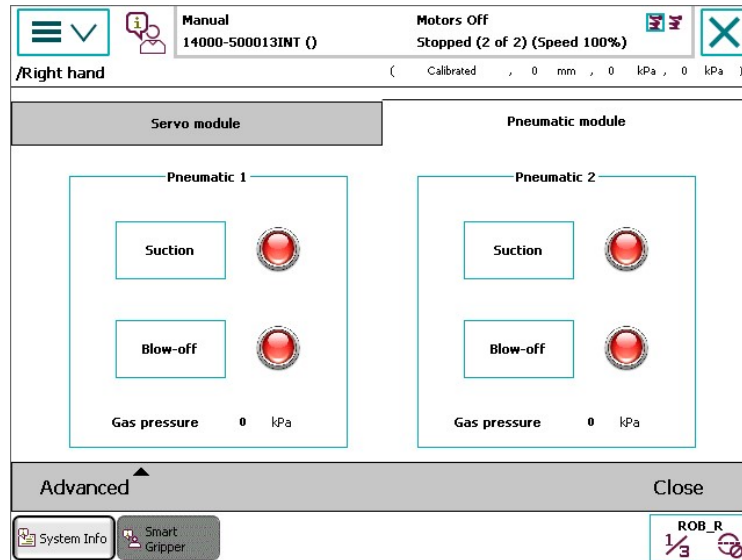

xx150000577

Two pneumatic block parts are available for different variants of the gripper. The status button of a specific operation that is activated is green. Suction and blow-off functions are exclusive to each other. That is, if one function is turned on, the other will be turned off.

#### Fast switch between left and right gripper

The **SmartGripper** add-in has a function of fast switching left and right gripper.

In the main page, select **Left Hand** or **Right Hand** to activate the relevant gripper and enter the gripper panel of the active gripper.

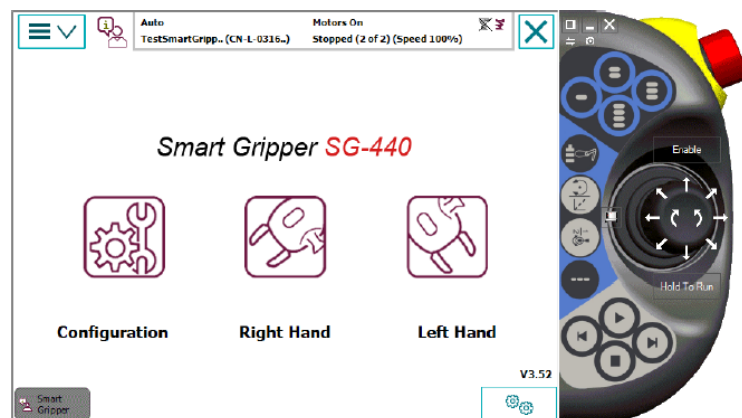

xx170000653

Continues on next page

In the left or right gripper panel, press the select mechanical unit button to switch the active gripper and to switch the gripper panel at the same time.

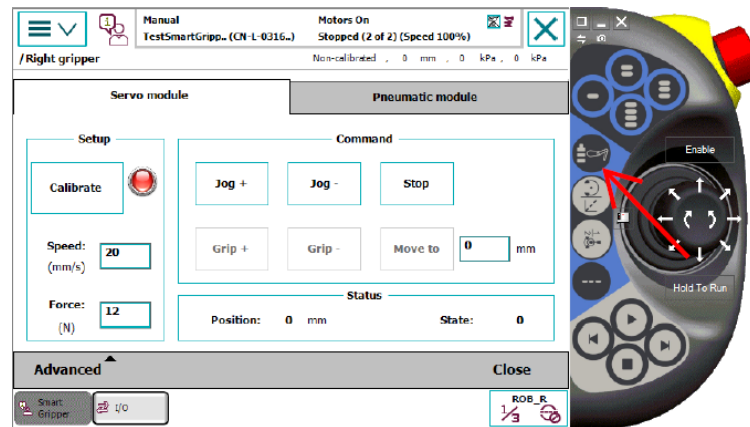

xx170000654

## 2 Installation and commissioning

---

### 2.6.1 Software commissioning

## 2.6 Commissioning

### 2.6.1 Software commissioning

---

#### Left and right gripper identity

When installing grippers for the first time or changing grippers on a robot, the Left and Right identity (chirality) has to be set up. The chirality is controlled by different IP addresses. For Right and Left, these are 192.168.125.30 and 192.168.125.40, respectively. These are the only possible IP addresses for a gripper.

The default IP address for a gripper is 192.168.125.30. That is, grippers are delivered to users as Right grippers.

---

#### Chirality setting procedure

	Action	Note
1	Shut off the power to the Left flange using the FlexPendant Gripper interface.	See <a href="#">IRB 14000 gripper FlexPendant application on page 44</a> .
2	Turn on the power to the Right flange, and verify that the LED on the Right gripper is On.	
3	Verify that the gripper on the Right flange is set up as the Right gripper. <ul style="list-style-type: none"><li>• If yes, proceed to step 5.</li><li>• If no, switch the IP address of the gripper using the FlexPendant Gripper interface.</li></ul>	
4	Reboot the gripper by shutting power off and then on.	
5	Shut off the power to the Right flange using the FlexPendant gripper interface.	See <a href="#">IRB 14000 gripper FlexPendant application on page 44</a> .
6	Turn on the power to the Left flange, and verify that the LED on the Left gripper is On.	
7	Verify that the gripper on the Left flange is set up as the Left gripper. <ul style="list-style-type: none"><li>• If yes, the setting ends.</li><li>• If no, switch the IP address of the gripper using the FlexPendant Gripper interface.</li></ul>	
8	Reboot the gripper by shutting power off and then on.	



## 2.6.2 Firmware update

### Overview

Two methods, FTP and TFTP, are available for updating the firmware of ABB smart grippers.

SmartGripper firmware version	TFTP method	FTP method
Earlier than Ver. 4.7	Yes	No
Ver. 4.7 or later	Yes	Yes

For details about how to check the current firmware version, see [Main page on page 47](#).

### FTP method

#### General

When the SmartGripper firmware is upgraded to version 4.7, the FTP method is automatically set as the default method and enables the self-upgrading of the firmware. With this method, the smart gripper will be able to automatically look for the firmware that is compatible with the SmartGripper add-in.



#### Note

During the SmartGripper firmware upgrade from an earlier version to version 4.7 or later, the power and Ethernet connections of the smart gripper must be stable; otherwise, unexpected problems may occur and the upgrade will fail. If the upgrade fails, the TFTP method will still be used for firmware upgrading.

#### Prerequisites

- Firmware with version 4.7 or later has been installed or been upgraded from an earlier version by the TFTP method.
- The default FTP account must be accessible.
- The corresponding version of the SmartGripper add-in must be installed on the IRB 14000 correctly.

#### Update procedure

After the SmartGripper is restarted, it will automatically look for the suitable firmware in the controller and then update the firmware.

### TFTP method

#### General

The SmartGripper firmware with a version earlier than 4.7 is limited to use the TFTP method for firmware updating.

If the SmartGripper firmware is in a version of 4.7 or later and the FTP method is used for firmware updating, you can manually switch to the TFTP method on the FlexPendant application by choosing **Advanced > Switch to TFTP** in the **Servo module** tab page. For details about the GUI of the **Servo module** tab page, see [Servo module tab page on page 49](#).

*Continues on next page*

## 2 Installation and commissioning

### 2.6.2 Firmware update

Continued

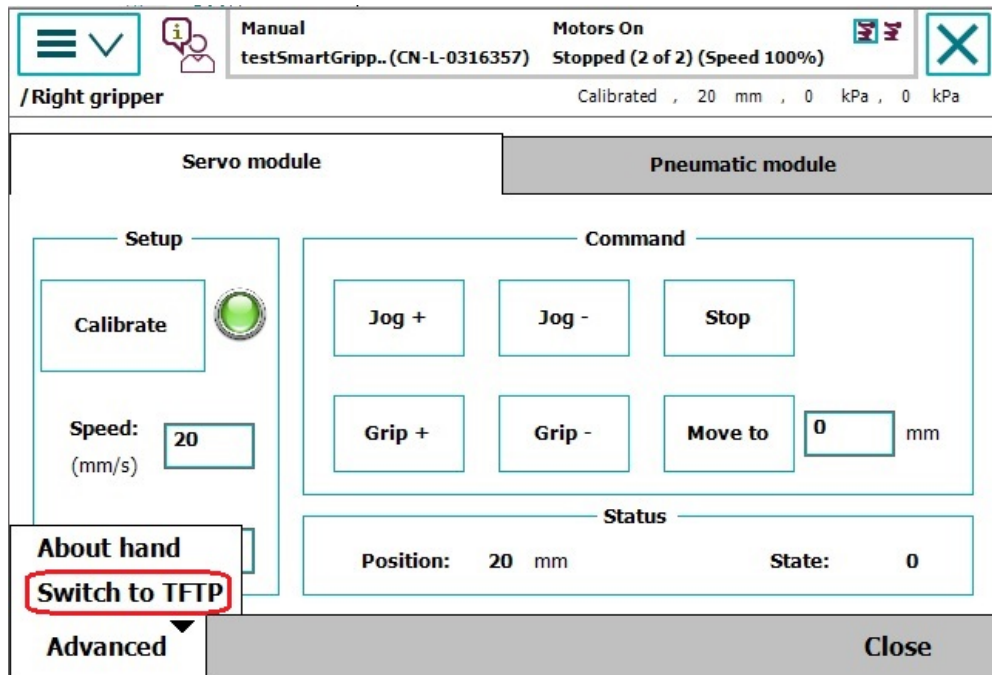

xx1600001270

The TFTP method works after the SmartGripper is restarted. However, the SmartGripper will switch back to the FTP method if a new firmware is successfully downloaded and upgraded, which has a lower downloading waiting time than the TFTP downloading (8s). If the new firmware upgrade fails, the SmartGripper will continue use the TFTP method.

#### Prerequisites

- PC with a network adapter  
The firewall of the PC must be shut down.
- Tftpd client  
Tftpd32 developed by Philippe JOUNIN is recommended. For details about Tftpd32, visit <http://tftpd32.jounin.net/>.
- Image binary file  
The file must be a BIN file and named like "HandSWx\_x.bin". Obtain the proper file by visiting the **ABB Download Center** website and searching with key words "IRB 14000 gripper software".

#### Update procedure

Use this procedure to update the firmware for the gripper:

- 1 Connect the PC to the Service port of the robot controller.  
Ensure that the IP address of the PC is obtained automatically or within the same subnet (192.168.125.xxx) with robot controller.

Continues on next page

- 2 Open the **Tftpd32** program and click **Tftp Client**. Then, configure the parameters shown in the following figure.

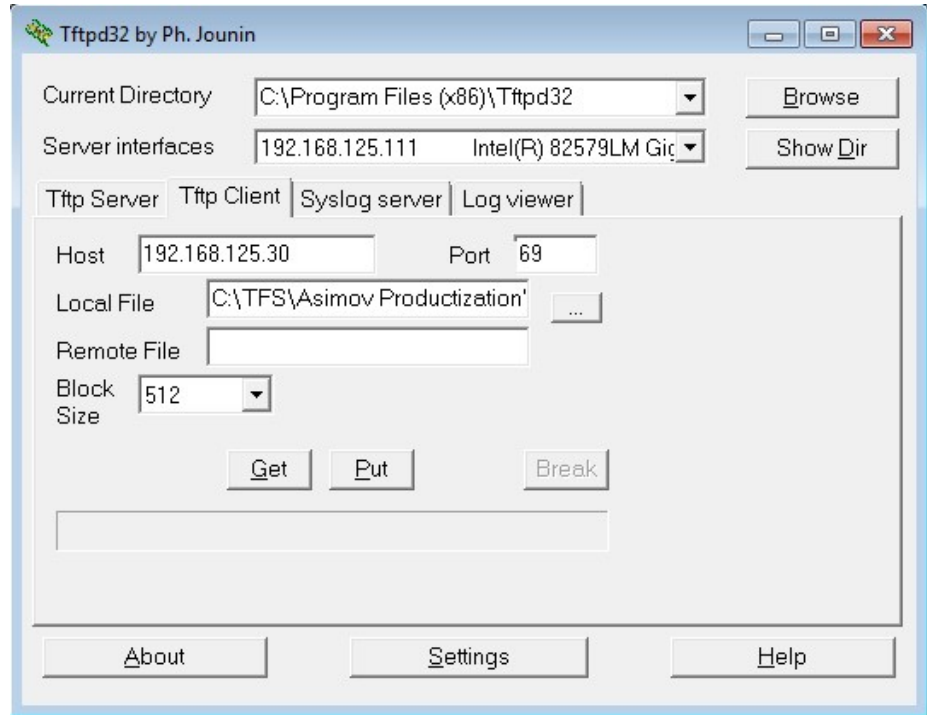

xx150000629

- The value of the **Server interfaces** parameter must be the IP address of the network adapter that is used to connect the PC with the robot.
  - The value of the **Host** parameter must be set to the IP address of the target gripper.  
192.168.125.30 is the default address for the Right gripper and 192.168.125.40 is for the left one.
  - The value of the **Port** parameter must be set to 69.
  - In the **Local File** text box, select the image stored on the PC with which the target gripper is to be upgraded.
  - The value of the **Block Size** parameter must be set to 512.
- 3 Power on the target gripper again through the **Enable Power To Gripper** button.
  - 4 When the network LED on the target gripper begins blinking, click the **Put** button on the **Tftp Client** tab page.



#### Note

There are 8 seconds to click the **Put** button before the gripper is booted with the current firmware.

- 5 Close the **Tftpd32** program after the transmission is completed.

*Continues on next page*

## 2 Installation and commissioning

---

### 2.6.2 Firmware update

*Continued*

The gripper is automatically booted with the firmware in the new version. Then, the firmware version of the gripper can be checked using the ABB Smart Gripper add-in.

2.6.3 System commissioning

Servo module

Prerequisites

- The gripper has been installed onto the robot arm correctly.
- The Smart Gripper add-in has been installed correctly.
- The gripper has been powered on and the communication is established.

Procedure

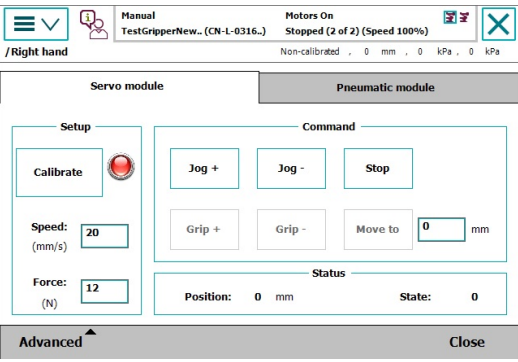
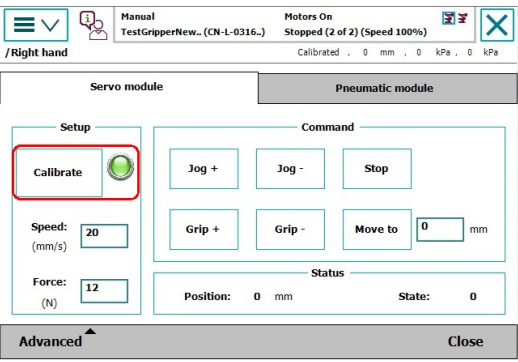
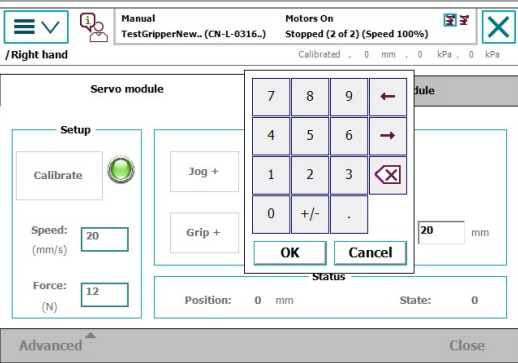
	Action	Note
1	Open Smart Gripper and choose the gripper to be tested.	See <a href="#">IRB 14000 gripper FlexPendant application on page 44</a> .
2	On the <b>Servo module</b> tab page, click the <b>Jog -</b> button until the two fingers of the gripper are in direct contact with each other, which is the zero position used for calibration.	 <p>xx150000833</p>
3	Click the <b>Calibrate</b> button to perform the calibration. The LED on the right of the <b>Calibrate</b> button is lightened.	 <p>xx150000834</p>
4	Enter 20 in the text box next to the <b>Move to</b> button and then click the button. The gripper moves to the position 20 mm far.	 <p>xx150000835</p>

Continues on next page

## 2 Installation and commissioning

### 2.6.3 System commissioning

Continued

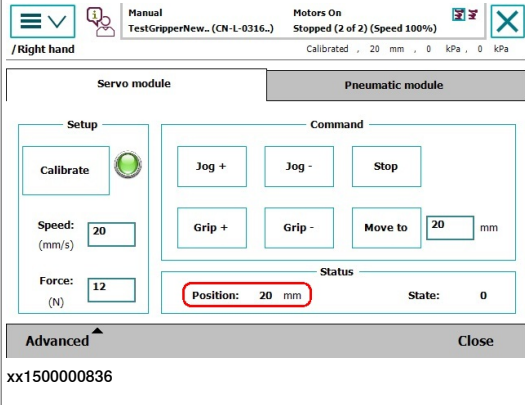
Action	Note
5	<p>Check the current position of the gripper, which is shown in <b>Position of the Status area</b>.</p>  <p>The screenshot shows the 'Pneumatic module' tab selected. Under the 'Status' section, 'Position: 20 mm' is highlighted with a red rectangle. Other visible elements include 'Speed: 20 (mm/s)', 'Force: 12 (N)', and 'State: 0'.</p>
6	<p>The gripper works properly if all the preceding actions complete normally.</p>

### Vacuum module

#### Prerequisites

- A gripper with at least one vacuum module has been installed onto the robot arm correctly.
- Suction tools including the suction cup and filter have been installed correctly.
- The Smart Gripper add-in has been installed correctly.
- The gripper has been powered on and the communication is established.
- A minimum of 5.5-bar air pressure has been supplied to the AIR interfaces on the left side panel of the IRB 14000 controller.
- A test object with a smooth surface has been prepared.

#### Procedure

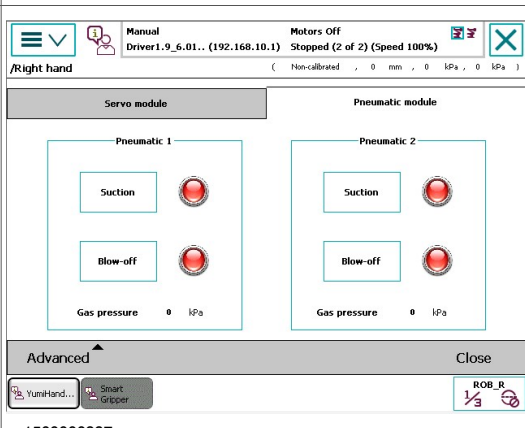
Action	Note
1	<p>Open Smart Gripper and choose the gripper to be tested.</p> <p>See <a href="#">IRB 14000 gripper FlexPendant application on page 44</a>.</p>
2	<p>Click <b>Pneumatic module</b> to enter the <b>Pneumatic module</b> tab page for commissioning the vacuum module.</p> <p>If any of <b>Pneumatic 1</b> or <b>Pneumatic 2</b> is available, the value of <b>Gas pressure</b> should be about <b>102 KPa</b>. If the value is <b>0 KPa</b>, no such vacuum module exists or the vacuum sensor of the vacuum module is broken.</p>  <p>The screenshot shows the 'Pneumatic module' tab with two columns: 'Pneumatic 1' and 'Pneumatic 2'. Each column has 'Suction' and 'Blow-off' buttons and a 'Gas pressure' display showing '0 kPa'. The interface also shows 'Motors Off' and 'Stopped (2 of 2) (Speed 100%)'.</p>

Continues on next page

	Action	Note
3	Check the air supply and test object to ensure that the air pressure to the AIR interfaces on the left side panel of the IRB 14000 controller is proper and the test object is in the proper position for the test.	
4	Click the <b>Suction</b> button. The LED next to the button is lightened.	
5	Verify that the object is picked up successfully. If yes, the value of <b>Gas pressure</b> should be less than <b>70 kPa</b> .	
6	The vacuum module works properly if all the preceding actions complete normally.	

### Vision module

#### Prerequisites

- A gripper with one vision module has been installed onto the robot arm correctly.
- The Smart Gripper add-in has been installed correctly.
- The IV option has been installed to use ABB Integrated Vision for testing the vision module.
- The gripper has been powered on and the communication is normally.
- A PC with the RobotStudio installed has been prepared.



#### Note

The Cognex In-Sight explorer can also be used for the commissioning of the vision module. In this case, a PC with the Cognex In-Sight software installed must be prepared.



#### CAUTION

Do not change the firmware of the Cognex AE3 camera; otherwise, communication errors will occur.

#### Procedure

See *Application manual - Integrated Vision* for how to perform commissioning on the vision module of the gripper. Verify that:

- The communication between the robot controller/PC and the vision module of the gripper is established.
- The IP address configuration of the vision module is correct. Users can select any available IP address on the subnet 192.168.125.xxx or use the DHCP.
- The vision module can take pictures normally using RobotStudio or Cognex In-Sight.

**This page is intentionally left blank**



## 3 Maintenance

### 3.1 Inspection activities

#### Required tools and equipment

Visual inspection, no tools are required.



#### CAUTION

All power to the manipulator must be shut off when inspecting the gripper. This can be done from the robot main switch on the controller.

#### Periodicity

Visually inspect the gripper regularly before starting an operation.

#### Inspecting the gripper

Part	Verify that...
Whole gripper	<ul style="list-style-type: none"> <li>The gripper is not loose from the robot arm.</li> <li>The screws attaching the gripper to the arm flange remain in place and are tightened.</li> <li>Make sure that there is grease on the spindles and sliders.</li> </ul>
Shell/Cover	<ul style="list-style-type: none"> <li>The shell/cover is not loose.</li> <li>No cracks or other mechanical damage.</li> </ul> <div style="margin-top: 10px;">  <b>Note</b>            Mechanical damage can only be inspected by removing the cover with appropriate tools and ESD precautions.         </div>
Finger	<ul style="list-style-type: none"> <li>No finger is loose.</li> <li>Gripping jaws are correctly mounted on finger and not loose.</li> <li>Workpiece fit properly in between gripping jaws, no wear.</li> <li>The screws attaching the fingers to the finger brackets remain in place and are tightened.</li> <li>No cracks or mechanical damage are in the fingers.</li> </ul>
Suction tools	Suction cup(s) and filter(s) are properly fastened and has no mechanical damage.
Camera window	The window is clean and has no damage.
LEDs and lightguides	The LEDs and lightguides are functional.

**This page is intentionally left blank**

---

# 4 Repair

## 4.1 Introduction

---

### Structure of this chapter

This chapter describes all repair activities recommended for the IRB 14000 gripper. It is made up of separate procedures, each describing a specific repair activity. Each procedure contains all the information required to perform the activity, for example spare parts numbers, required special tools, and materials. The procedures are gathered in sections, divided according to the component location on the IRB 14000 gripper.

---

### Required equipment

The details of the equipment required to perform a specific repair activity are listed in the respective procedures. The details of equipment are also available in different lists in the chapter [Reference information on page 153](#).

---

### Safety information

There are general safety information and specific safety information. The specific safety information describes the danger and safety risks while performing specific steps in a procedure. Make sure to read through the chapter [Safety on page 13](#) before commencing any service work.



#### Note

If the robot where the gripper shall be mounted is connected to power, always ensure that the robot is OFF and is connected to protective earth before starting any installation work.

*Product manual - IRB 14000*

## 4 Repair

### 4.2 Replacing the filter and suction cup

### 4.2 Replacing the filter and suction cup

#### Location of the filter and suction cup

The filter and suction cup are located as shown in the figure.



xx150000628

A	Suction cup
B	Filter

#### Required tools and equipment

Equipment	Article number	Note
Standard toolkit	-	Content is defined in section <a href="#">Standard toolkit on page 155</a> .

#### Required spare parts

Spare part	Article number	Note
Vacuum filter	3HAC047854-001	
Vacuum rubber cup	3HAC047927-001	

*Continues on next page*

**Removing the filter and suction cup**

Use this procedure to remove the filter and suction cup.

**Removing the whole gripper**

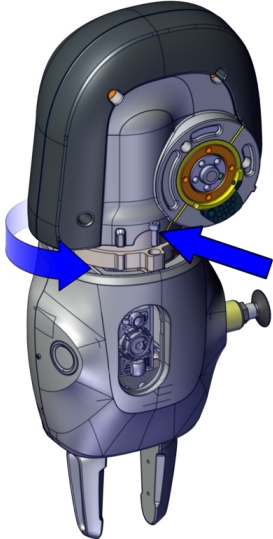
	Action	Note
1	<p> <b>CAUTION</b></p> <p>Do not install or remove the gripper when power is on. Otherwise damage to the electronics may occur.</p> <p>Always check the gripper power status before commencing any service work. Make sure that all supplies for electrical power and air pressure are turned off.</p>	<p>For details about how to check the power status and how to turn off gripper power using FlexPendant, see <a href="#">Configuration page on page 48</a>.</p>
2	<p>Rotate the arm tool flange on the axis 6 of the robot to make one of the three screw holes accessible, and then remove the screw.</p>	 <p>xx1500001390</p>
3	<p>Repeat the preceding step to remove the other two screws to detach the whole gripper from the arm tool flange.</p>	



Continues on next page

## 4 Repair

### 4.2 Replacing the filter and suction cup

*Continued*

#### Removing the filter and suction cup

	Action	Note/Illustration
1	Twist and remove the filter and suction cup.   <b>Note</b>  The filter and suction cup are provided as a set and recommended to be replaced together. A built-in screw is mounted on the filter, which enables a simple removal of filter and suction cup by just twisting them.	 <p data-bbox="957 728 1066 745">xx1400002624</p> <p data-bbox="991 768 1161 824"> <b>A</b> Suction cup  <b>B</b> Filter         </p>

#### Refitting the filter and suction cup

Use this procedure to refit the filter and suction cup.

#### Refit the filter and suction cup

	Action	Note/Illustration
1	Refit the filter and suction cup by twisting them.	<p data-bbox="957 1070 1410 1126">             Vacuum filter , 3HAC047854-001 Vacuum rubber cup , 3HAC047927-001           </p>  <p data-bbox="957 1496 1066 1514">xx1400002624</p> <p data-bbox="991 1536 1161 1592"> <b>A</b> Suction cup  <b>B</b> Filter         </p>

#### Refitting the whole gripper

	Action	Note
1	 <b>CAUTION</b>  Do not install or remove the gripper when power is on. Otherwise damage to the electronics may occur.  Always check the gripper power status before commencing any service work.. Make sure that all supplies for electrical power and air pressure are turned off.	For details about how to check the power status and how to turn off gripper power using FlexPendant, see <a href="#">Configuration page on page 48</a> .

*Continues on next page*

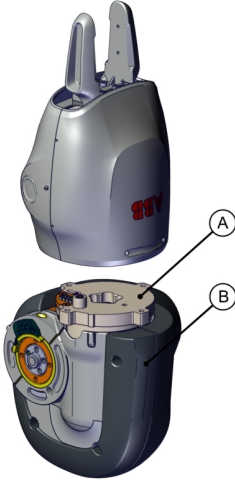
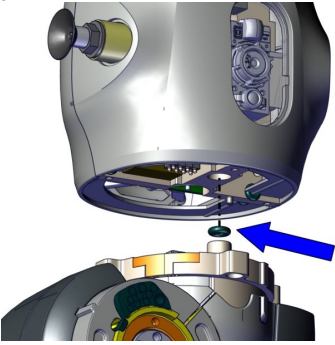
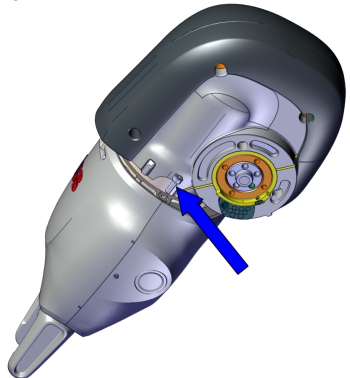
	Action	Note
2	Position the gripper to the arm tool flange on the axis 6 of the robot.	 <p>xx1500001394</p> <p>A Arm tool flange B Axis 6 of the robot</p>
3	Use the guide pin and air hose hole to make the gripper align with the arm tool flange.	For the positions of the guide pin and air hose hole, see <a href="#">Mounting flange on page 35</a> .
4	For the gripper with a vacuum module, check the O-ring in the air hose hole. Replace if damaged.	<p>O-ring 4x2: 3HAC063220-001 (1 pcs)</p>  <p>xx1500001625</p>
5	Rotate the arm tool flange with the gripper to make one of the three screw holes accessible and then refit the screw.	<p>Screw: M2.5 x 8, 3HAC051701-001 (1 pcs)</p>  <p>xx1500001391</p>

Continues on next page

## 4 Repair

### 4.2 Replacing the filter and suction cup

Continued

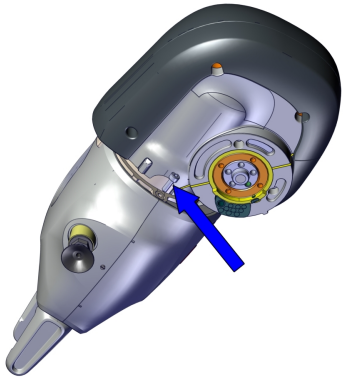
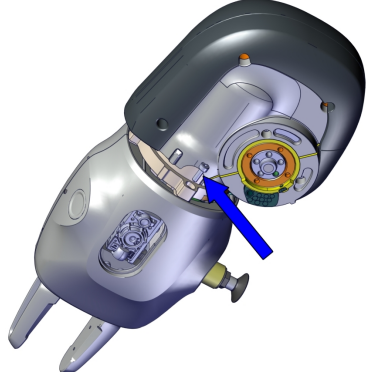
	Action	Note
6	Rotate the flange with 180 degrees to access the opposite screw hole and then refit the screw.	Screw: M2.5 x 8, 3HAC051701-001 (1 pcs)  xx1500001392
7	Rotate the flange with 90 degrees to access the last screw hole and then refit the screw.	Screw: M2.5 x 8, 3HAC051701-001 (1 pcs)  xx1500001393
8	Turn on the power and air supply to the gripper and then perform commissioning on the gripper.	



## 4.3 Replacing the fingers

### Location of the fingers

The fingers are located as shown in the figure.

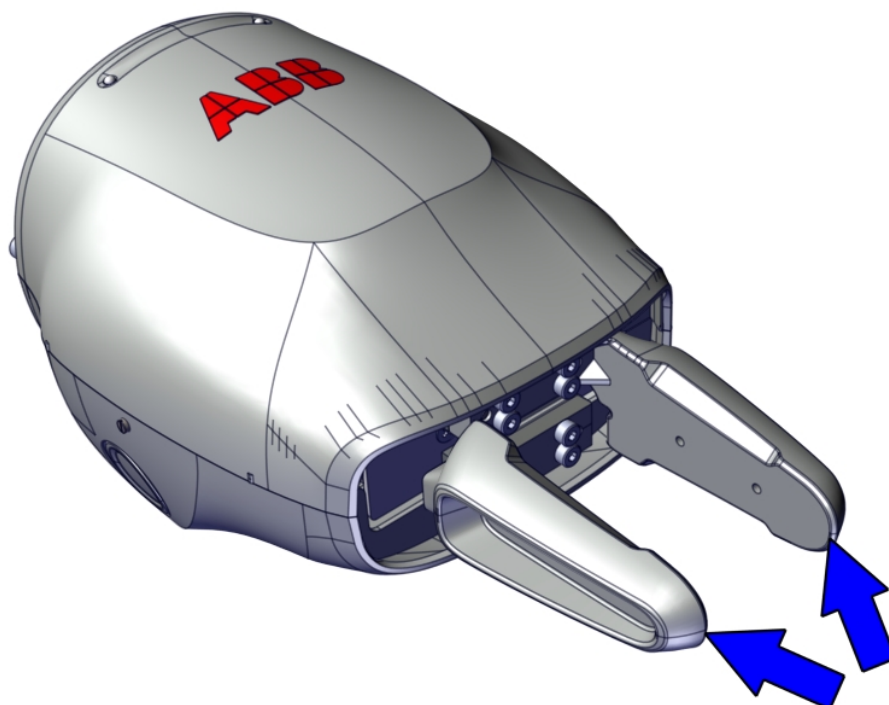

xx1400002616

### Required tools and equipment

Equipment	Article number	Note
Standard toolkit	-	Content is defined in section <a href="#">Standard toolkit on page 155</a> .

### Required spare parts

Spare part	Article number	Note
Fingers	3HAC052976-001	Two getting-started fingers are delivered with the gripper. It is also possible to use customized fingers based on actual requirements.
Hex socket head cap screw	3HAC051700-001	M2x7, class 8.8

*Continues on next page*

## 4 Repair

### 4.3 Replacing the fingers

*Continued*

#### Removing the fingers

Use this procedure to remove the fingers.

#### Removing the whole gripper

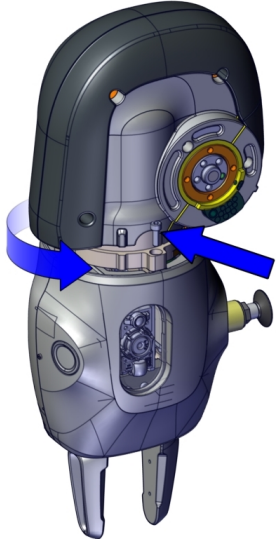
	Action	Note
1	 <b>CAUTION</b> Do not install or remove the gripper when power is on. Otherwise damage to the electronics may occur. Always check the gripper power status before commencing any service work. Make sure that all supplies for electrical power and air pressure are turned off.	For details about how to check the power status and how to turn off gripper power using FlexPendant, see <a href="#">Configuration page on page 48</a> .
2	Rotate the arm tool flange on the axis 6 of the robot to make one of the three screw holes accessible, and then remove the screw.	  xx1500001390
3	Repeat the preceding step to remove the other two screws to detach the whole gripper from the arm tool flange.	

*Continues on next page*

Removing the fingers

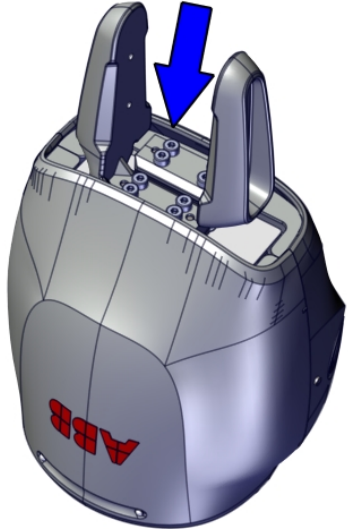
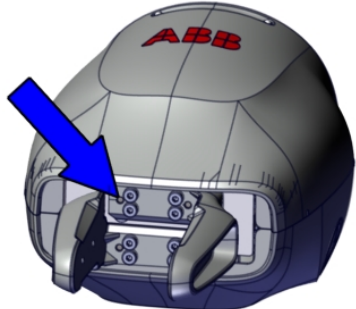
	Action	Note/Illustration
1	Remove the screws that hold the finger.	 <p>xx1400002617</p>
2	If two pins are used for positioning, remove the pins.	 <p>xx1500000607</p>
3	Pull out the finger from the finger flange.	

Refitting the fingers

Use this procedure to refit the fingers.

Refitting the fingers

	Action	Note/Illustration
1	Place a new finger on the finger flange.	Fingers , 3HAC052976-001

Continues on next page

## 4 Repair

### 4.3 Replacing the fingers

Continued

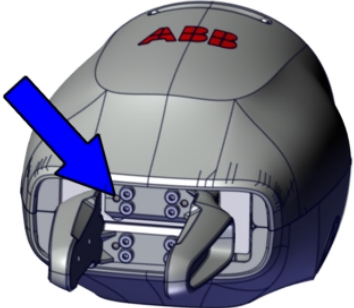
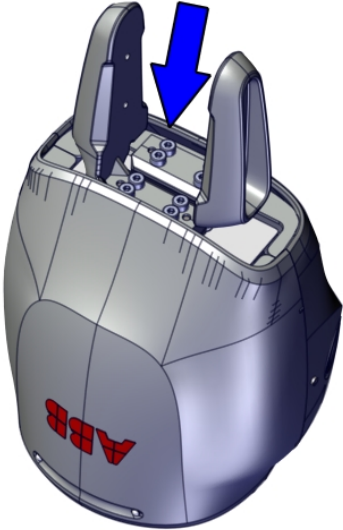
	Action	Note/Illustration
2	<p>For metal fingers, insert two pins for positioning.</p> <p> <b>Note</b></p> <p>Pins can be designed based on actual requirements. For details about the hole configuration, see <a href="#">Hole configuration, mounting base on page 37</a>.</p>	<p>Pin (2 pcs for each finger) 2x6, h8 ISO 2338</p>  <p>xx150000607</p>
3	<p>Refit and tighten the screws.</p>	<p>Hex socket head cap screw , 3HAC051700-001: M2x7, class 8.8 (8 pcs) Tightening torque: 0.2 Nm</p>  <p>xx1400002617</p>

### Refitting the whole gripper

	Action	Note
1	<p> <b>CAUTION</b></p> <p>Do not install or remove the gripper when power is on. Otherwise damage to the electronics may occur.</p> <p>Always check the gripper power status before commencing any service work.. Make sure that all supplies for electrical power and air pressure are turned off.</p>	<p>For details about how to check the power status and how to turn off gripper power using FlexPendant, see <a href="#">Configuration page on page 48</a>.</p>

Continues on next page

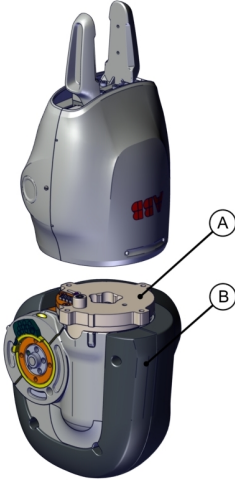
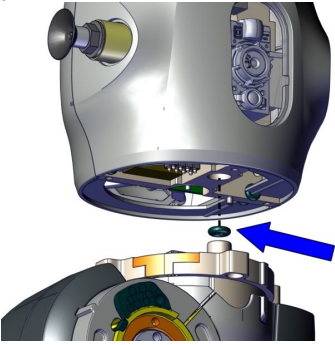
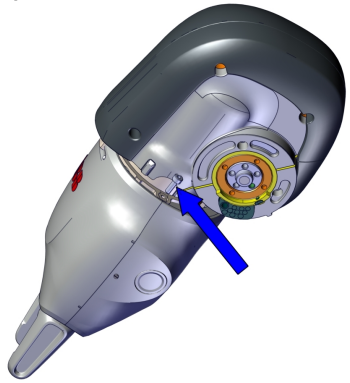
	Action	Note
2	Position the gripper to the arm tool flange on the axis 6 of the robot.	 <p>xx1500001394</p> <p>A Arm tool flange B Axis 6 of the robot</p>
3	Use the guide pin and air hose hole to make the gripper align with the arm tool flange.	For the positions of the guide pin and air hose hole, see <a href="#">Mounting flange on page 35</a> .
4	For the gripper with a vacuum module, check the O-ring in the air hose hole. Replace if damaged.	<p>O-ring 4x2: 3HAC063220-001 (1 pcs)</p>  <p>xx1500001625</p>
5	Rotate the arm tool flange with the gripper to make one of the three screw holes accessible and then refit the screw.	<p>Screw: M2.5 x 8, 3HAC051701-001 (1 pcs)</p>  <p>xx1500001391</p>

Continues on next page

## 4 Repair

### 4.3 Replacing the fingers

Continued

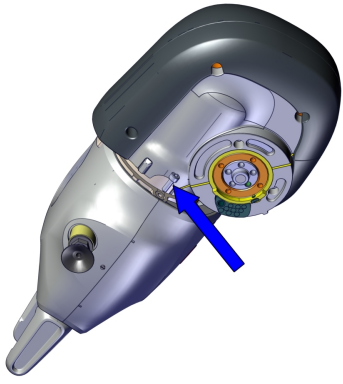
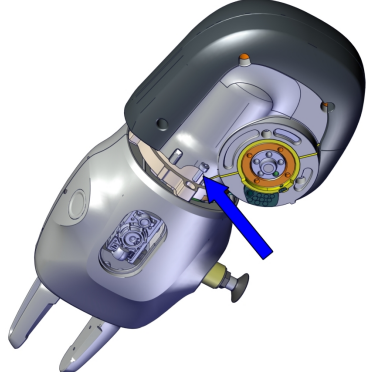
	Action	Note
6	Rotate the flange with 180 degrees to access the opposite screw hole and then refit the screw.	Screw: M2.5 x 8, 3HAC051701-001 (1 pcs)  xx1500001392
7	Rotate the flange with 90 degrees to access the last screw hole and then refit the screw.	Screw: M2.5 x 8, 3HAC051701-001 (1 pcs)  xx1500001393
8	Turn on the power and air supply to the gripper and then perform commissioning on the gripper.	

## 4.4 Replacing the shell

### Location of the shell

The shell is located as shown in the figure.

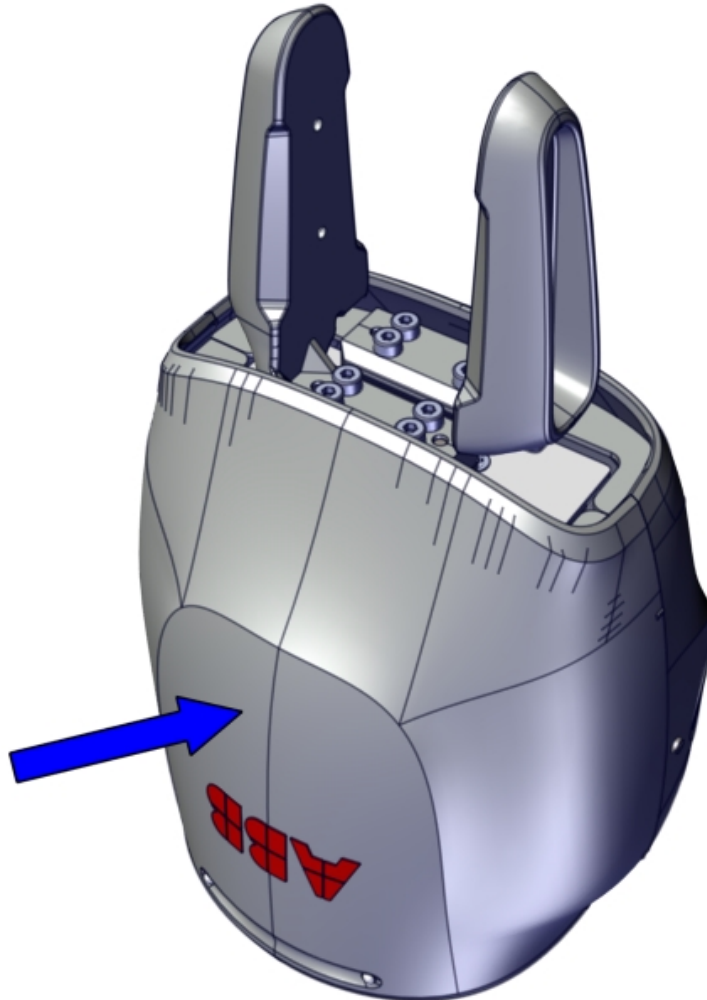

xx150000638

### Required tools and equipment

Equipment	Article number	Note
Standard toolkit	-	Content is defined in section <a href="#">Standard toolkit on page 155</a> .

### Required spare parts

Spare part	Article number	Note
Shell complete (with camera window)	3HAC066000-001	Used for the gripper with a camera. Use together with O-ring 1.8x1.8 , 3HAB3772-175

*Continues on next page*

## 4 Repair

### 4.4 Replacing the shell

Continued

Spare part	Article number	Note
Shell complete (without camera window)	3HAC066001-001	Used for the gripper without a camera. Use together with O-ring 1.8x1.8 , 3HAB3772-175
O-ring 1.8x1.8	3HAB3772-175	

### Removing the shell

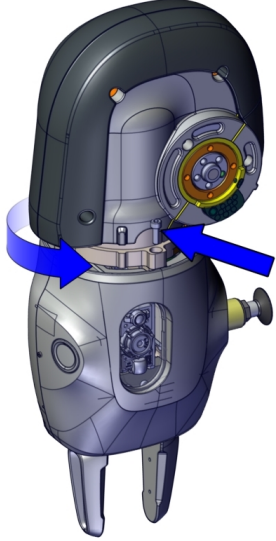

#### Removing the whole gripper

	Action	Note
1	 <b>CAUTION</b> Do not install or remove the gripper when power is on. Otherwise damage to the electronics may occur. Always check the gripper power status before commencing any service work. Make sure that all supplies for electrical power and air pressure are turned off.	For details about how to check the power status and how to turn off gripper power using FlexPendant, see <a href="#">Configuration page on page 48</a> .
2	Rotate the arm tool flange on the axis 6 of the robot to make one of the three screw holes accessible, and then remove the screw.	 xx1500001390
3	Repeat the preceding step to remove the other two screws to detach the whole gripper from the arm tool flange.	

Continues on next page



Removing the filter and suction cup

	Action	Note/Illustration
1	<p>Twist and remove the filter and suction cup.</p> <p> <b>Note</b></p> <p>The filter and suction cup are provided as a set and recommended to be replaced together. A built-in screw is mounted on the filter, which enables a simple removal of filter and suction cup by just twisting them.</p>	 <p>xx1400002624</p> <p>A Suction cup B Filter</p>

Removing the shell

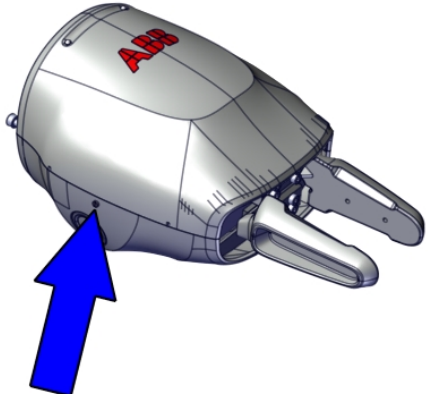
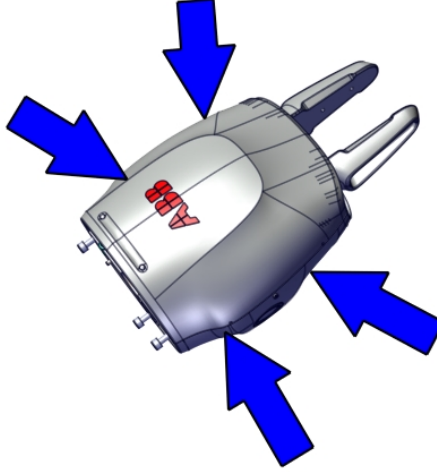
	Action	Note/Illustration
1	<p>Remove the screws that fasten the shell.</p>	 <p>xx1500000759</p>
2	<p>Press the locations shown in the figure gently to detach the shell.</p> <p>The shell consists of two parts:</p> <ul style="list-style-type: none"> <li>• lower shell</li> <li>• upper shell</li> </ul>	 <p>xx1400002152</p>

Continues on next page

## 4 Repair

### 4.4 Replacing the shell

*Continued*

#### Refitting the shell

#### Refitting the shell

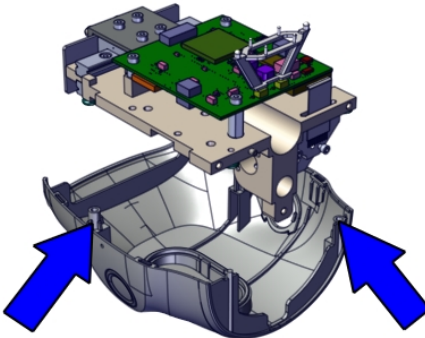
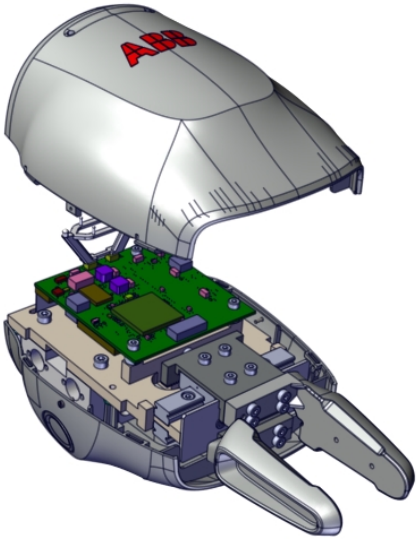
	Action	Note/Illustration
1	Put the lower shell to the base plate and insert the locating pins on the lower shell to the location holes on the base plate.	<p data-bbox="960 418 1399 533">Shell complete (with camera window), 3HAC066000-001 Shell complete (without camera window), 3HAC066001-001</p>  <p data-bbox="960 972 1066 992">xx1400002155</p>
2	Put the upper shell to the base plate.	 <p data-bbox="960 1619 1066 1639">xx1500000769</p>
3	Press the lower shell and upper shell together.	

*Continues on next page*

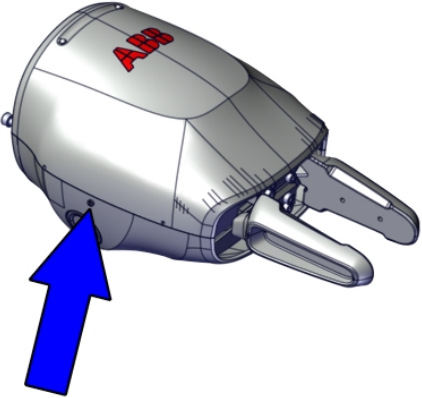
	Action	Note/Illustration
4	Refit the screws to fasten the shell.	<p>Screw M1.2 (2 pcs)</p>  <p>xx150000759</p>

Refit the filter and suction cup

	Action	Note/Illustration
1	Refit the filter and suction cup by twisting them.	<p>Vacuum filter , 3HAC047854-001 Vacuum rubber cup , 3HAC047927-001</p>  <p>xx1400002624</p> <p>A Suction cup B Filter</p>

Refitting the whole gripper

	Action	Note
1	<p> <b>CAUTION</b></p> <p>Do not install or remove the gripper when power is on. Otherwise damage to the electronics may occur.</p> <p>Always check the gripper power status before commencing any service work.. Make sure that all supplies for electrical power and air pressure are turned off.</p>	<p>For details about how to check the power status and how to turn off gripper power using FlexPendant, see <a href="#">Configuration page on page 48</a>.</p>

Continues on next page

## 4 Repair

### 4.4 Replacing the shell

Continued

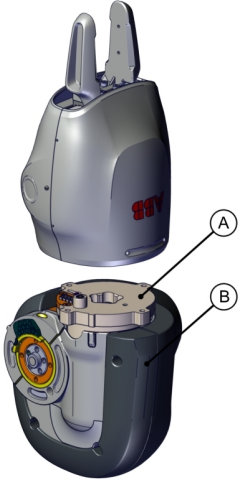
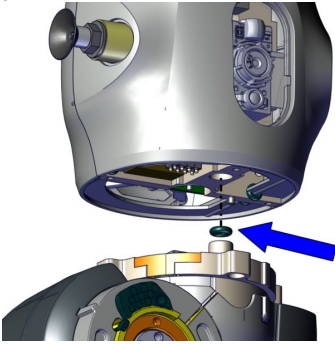
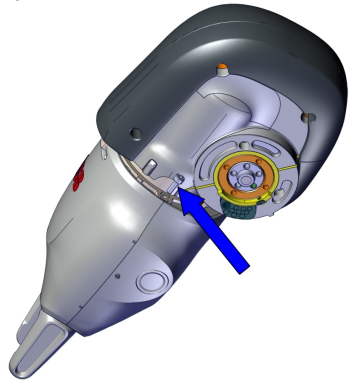
	Action	Note
2	Position the gripper to the arm tool flange on the axis 6 of the robot.	 <p>xx1500001394</p> <p>A Arm tool flange B Axis 6 of the robot</p>
3	Use the guide pin and air hose hole to make the gripper align with the arm tool flange.	For the positions of the guide pin and air hose hole, see <a href="#">Mounting flange on page 35</a> .
4	For the gripper with a vacuum module, check the O-ring in the air hose hole. Replace if damaged.	<p>O-ring 4x2: 3HAC063220-001 (1 pcs)</p>  <p>xx1500001625</p>
5	Rotate the arm tool flange with the gripper to make one of the three screw holes accessible and then refit the screw.	<p>Screw: M2.5 x 8, 3HAC051701-001 (1 pcs)</p>  <p>xx1500001391</p>

Continues on next page

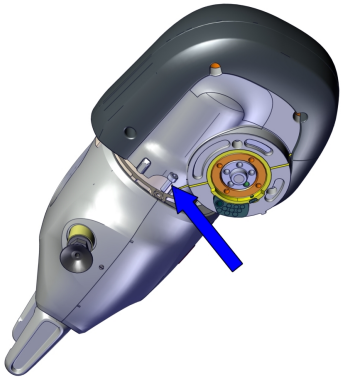
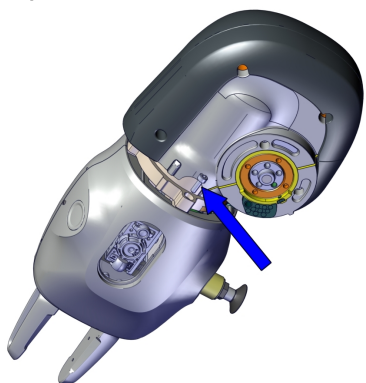
	Action	Note
6	Rotate the flange with 180 degrees to access the opposite screw hole and then refit the screw.	<p>Screw: M2.5 x 8, 3HAC051701-001 (1 pcs)</p>  <p>xx1500001392</p>
7	Rotate the flange with 90 degrees to access the last screw hole and then refit the screw.	<p>Screw: M2.5 x 8, 3HAC051701-001 (1 pcs)</p>  <p>xx1500001393</p>
8	Turn on the power and air supply to the gripper and then perform commissioning on the gripper.	

## 4 Repair

### 4.5 Replacing the pneumatic block

### 4.5 Replacing the pneumatic block

#### Location of the pneumatic block

The pneumatic block is located as shown in the figure.

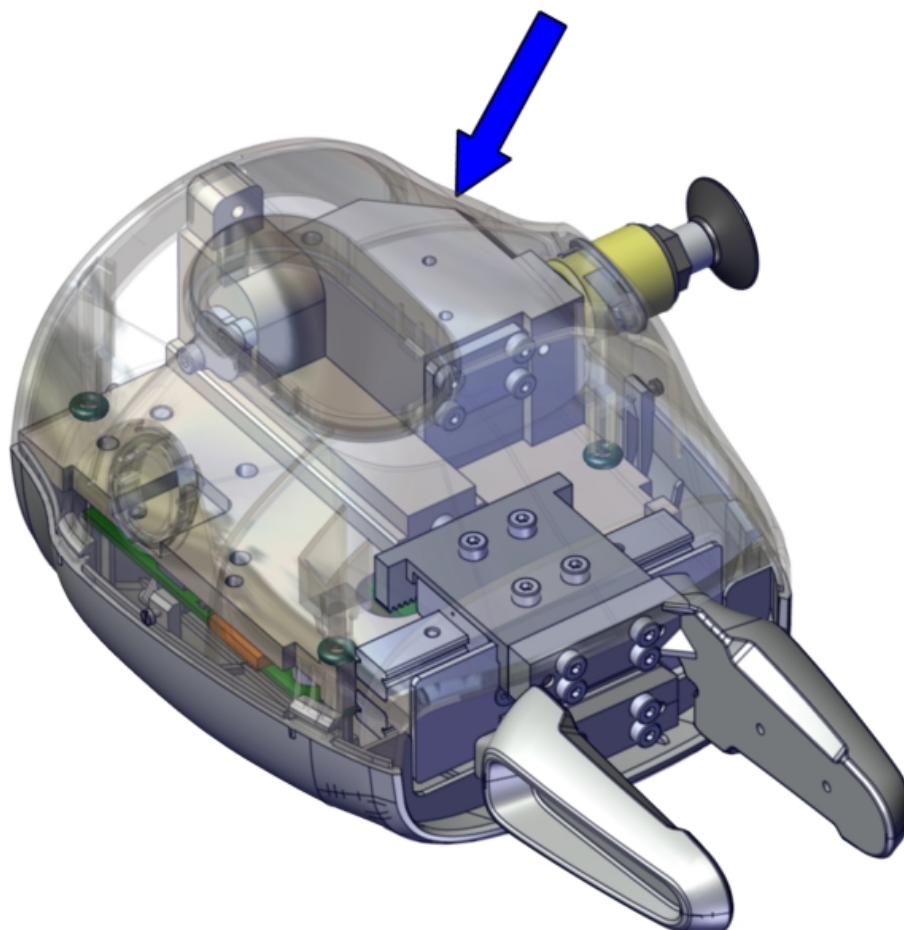

xx1400002626

#### Required tools

Equipment	Article number	Note
Standard toolkit	-	Content is defined in section <a href="#">Standard toolkit on page 155</a> .

#### Required spare parts

Spare part	Article number	Note
Pneumatic block	3HAC054989-001	
Pneumatic block	3HAC054990-001	
Vacuum sensor	3HAC047823-001	
Pneumatic block connector board	3HAC051609-001	

*Continues on next page*

Spare part	Article number	Note
FFC for pneumatic block connector board	3HAC051610-002	9 pin; pitch 1.0
FFC for camera	3HAC054157-002	31 pin; 76-mm length

#### Removing the pneumatic block

#### Removing the whole gripper

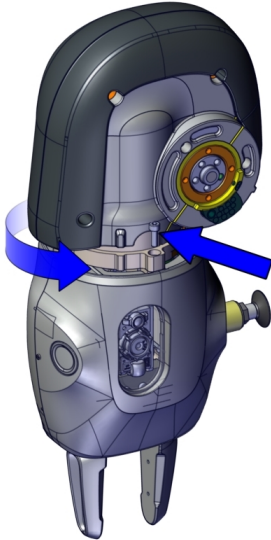
	Action	Note
1	 <b>CAUTION</b> Do not install or remove the gripper when power is on. Otherwise damage to the electronics may occur. Always check the gripper power status before commencing any service work. Make sure that all supplies for electrical power and air pressure are turned off.	For details about how to check the power status and how to turn off gripper power using FlexPendant, see <a href="#">Configuration page on page 48</a> .
2	Rotate the arm tool flange on the axis 6 of the robot to make one of the three screw holes accessible, and then remove the screw.	 <small>xx1500001390</small>
3	Repeat the preceding step to remove the other two screws to detach the whole gripper from the arm tool flange.	



*Continues on next page*

## 4 Repair

### 4.5 Replacing the pneumatic block

*Continued*

#### Removing the filter and suction cup

Action	Note/Illustration
<p>1 Twist and remove the filter and suction cup.</p> <p> <b>Note</b></p> <p>The filter and suction cup are provided as a set and recommended to be replaced together. A built-in screw is mounted on the filter, which enables a simple removal of filter and suction cup by just twisting them.</p>	 <p>xx1400002624</p> <p>A Suction cup B Filter</p>

#### Removing the shell

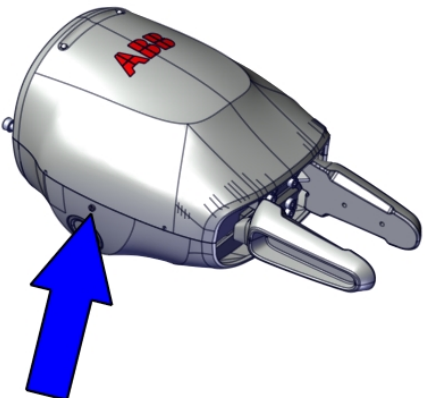
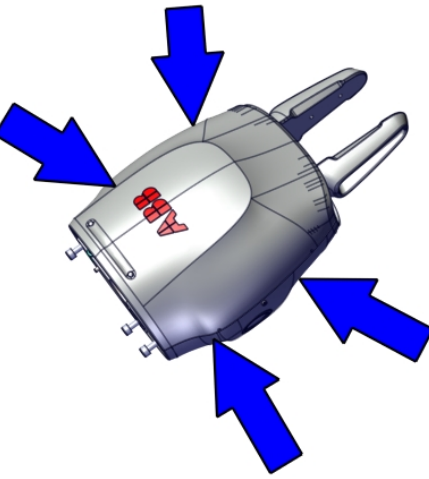
Action	Note/Illustration
<p>1 Remove the screws that fasten the shell.</p>	 <p>xx1500000759</p>
<p>2 Press the locations shown in the figure gently to detach the shell.</p> <p>The shell consists of two parts:</p> <ul style="list-style-type: none"> <li>• lower shell</li> <li>• upper shell</li> </ul>	 <p>xx1400002152</p>

*Continues on next page*

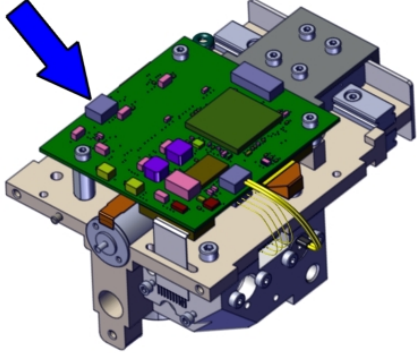
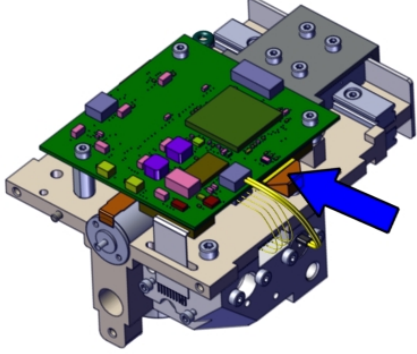
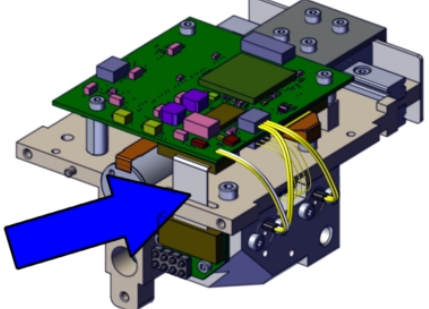

Removing the pneumatic block

	Action	Note/Illustration
1	Disconnect the connectors from the vacuum sensor and valve.	 <p>xx1400002618</p>
2	Disconnect the motor cable.	 <p>xx1400002619</p>
3	For the left pneumatic block, disconnect the flexible cable for connector board.	 <p>xx150000608</p>

Continues on next page

## 4 Repair

### 4.5 Replacing the pneumatic block

*Continued*

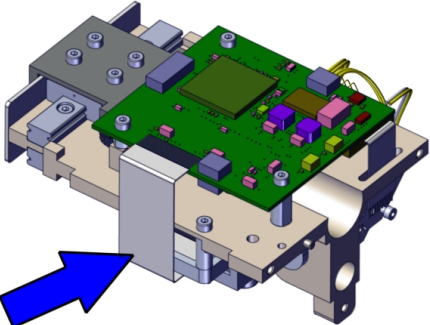
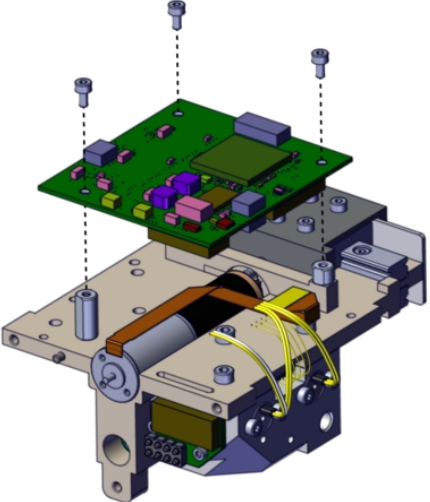
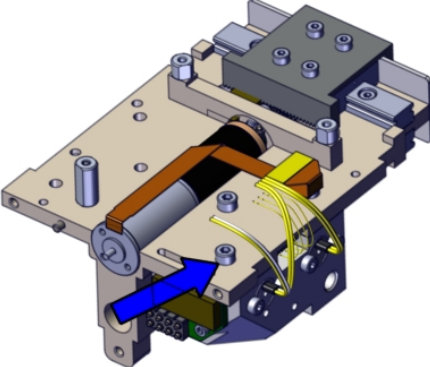
	Action	Note/Illustration
4	For the gripper with a camera, disconnect the flexible flat cable (FFC) from the camera.	 <p>xx150000612</p>
5	Remove the screws to detach the main PCB.	 <p>xx1400002621</p>
6	Remove the screws to detach the pneumatic block from the servo base.	 <p>xx150000610</p>

*Continues on next page*

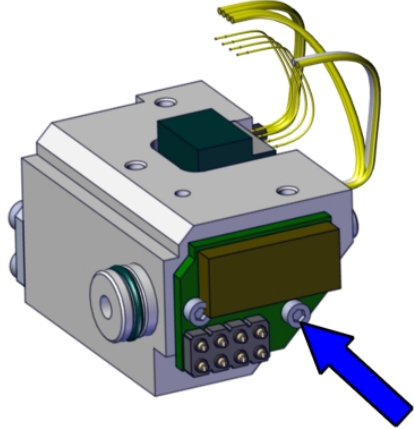
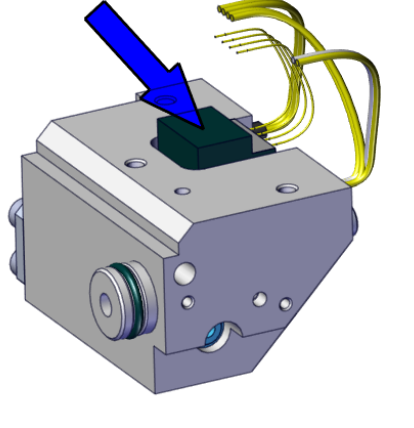
	Action	Note/Illustration
7	For the left pneumatic block, remove the screws to remove the connector board.	 <p>xx150000609</p>
8	Remove the vacuum sensor.	 <p>xx210000696</p>

**Refitting the pneumatic block**

Refitting the pneumatic block

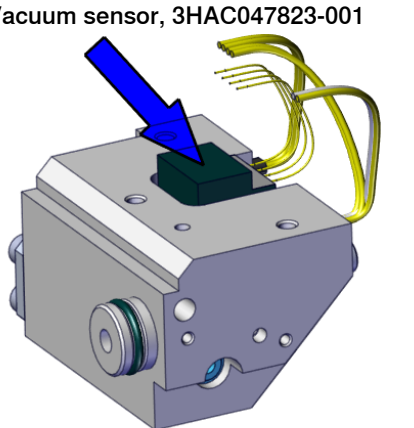
	Action	Note/Illustration
1	Refit the vacuum sensor.	<p>Vacuum sensor, 3HAC047823-001</p>  <p>xx210000696</p>

Continues on next page

## 4 Repair

### 4.5 Replacing the pneumatic block

*Continued*

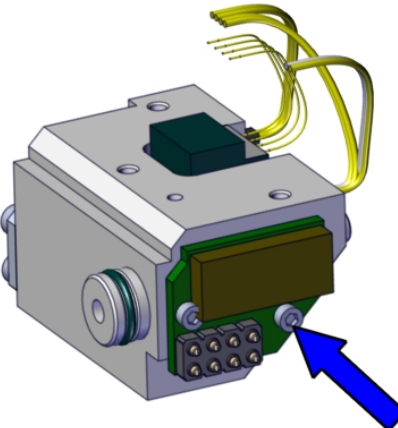
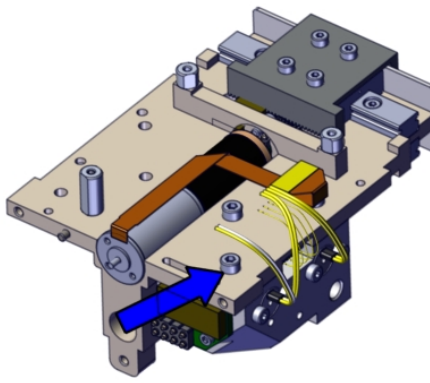
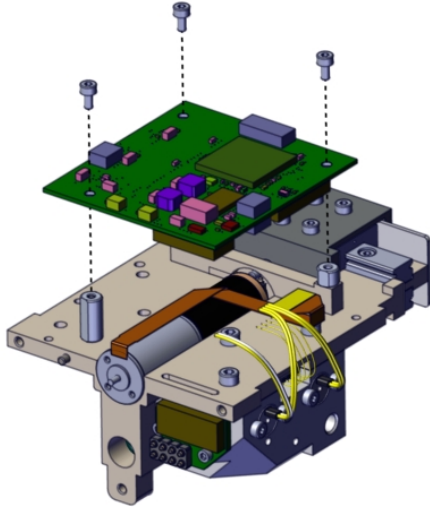
	Action	Note/Illustration
2	For the left pneumatic block, refit the connector board with screws.	<p>Pneumatic block connector board, 3HAC051609-001</p>  <p>xx150000609</p>
3	Refit the new pneumatic block to the servo base with screws.	<p>Screw M2.5 (3 pcs) Pneumatic block, 3HAC054989-001 Pneumatic block, 3HAC054990-001</p>  <p>xx150000610</p>
4	Refit the main PCB.	 <p>xx1400002621</p>

*Continues on next page*

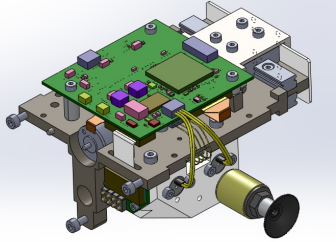
	Action	Note/Illustration
5	Check the FFC for the pneumatic block connector board and FFC for the camera. Replace if damaged.	FFC for pneumatic block connector board, 3HAC051610-002 FFC for camera, 3HAC054157-002
6	Reconnect the connectors: <ul style="list-style-type: none"> <li>• Vacuum sensor and valve</li> <li>• motor cable</li> <li>• FFC for the pneumatic block connector board</li> <li>• FFC for the camera</li> </ul>	 <p>xx1400002628</p>

Refitting the shell

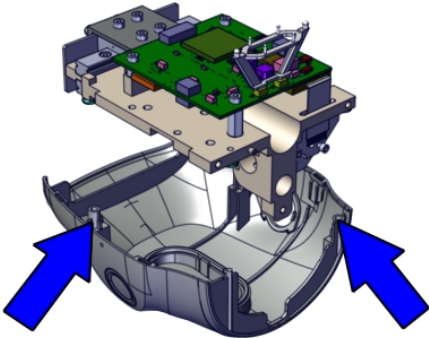
	Action	Note/Illustration
1	Put the lower shell to the base plate and insert the locating pins on the lower shell to the location holes on the base plate.	Shell complete (with camera window), 3HAC066000-001 Shell complete (without camera window), 3HAC066001-001   <p>xx1400002155</p>

*Continues on next page*

## 4 Repair

### 4.5 Replacing the pneumatic block

*Continued*

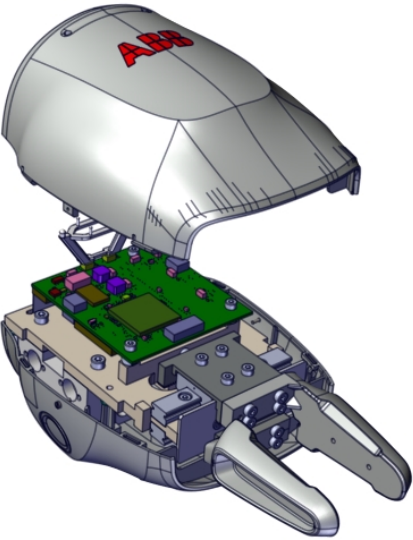
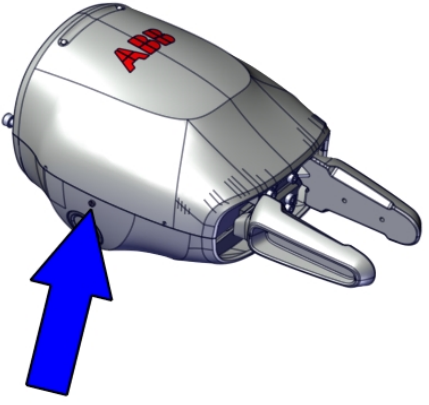
	Action	Note/Illustration
2	Put the upper shell to the base plate.	 <p>xx150000769</p>
3	Press the lower shell and upper shell together.	
4	Refit the screws to fasten the shell.	<p>Screw M1.2 (2 pcs)</p>  <p>xx150000759</p>

*Continues on next page*

Refit the filter and suction cup

	Action	Note/Illustration
1	Refit the filter and suction cup by twisting them.	<p>Vacuum filter , 3HAC047854-001 Vacuum rubber cup , 3HAC047927-001</p>  <p>xx1400002624</p> <p>A Suction cup B Filter</p>

Refitting the whole gripper

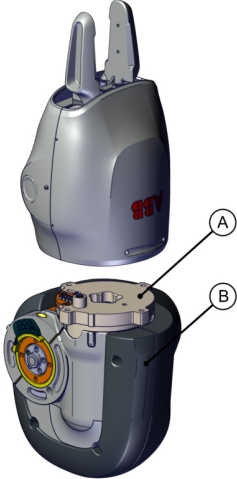
	Action	Note
1	<p> <b>CAUTION</b></p> <p>Do not install or remove the gripper when power is on. Otherwise damage to the electronics may occur.</p> <p>Always check the gripper power status before commencing any service work.. Make sure that all supplies for electrical power and air pressure are turned off.</p>	<p>For details about how to check the power status and how to turn off gripper power using FlexPendant, see <a href="#">Configuration page on page 48</a>.</p>
2	Position the gripper to the arm tool flange on the axis 6 of the robot.	 <p>xx1500001394</p> <p>A Arm tool flange B Axis 6 of the robot</p>

Continues on next page

## 4 Repair

### 4.5 Replacing the pneumatic block

Continued

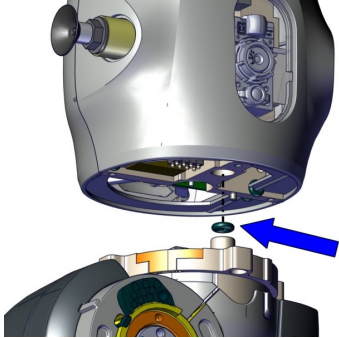
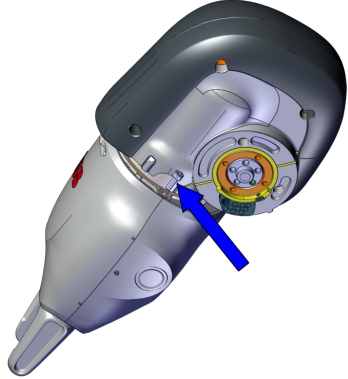
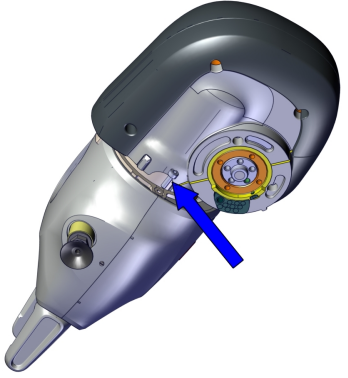
	Action	Note
3	Use the guide pin and air hose hole to make the gripper align with the arm tool flange.	For the positions of the guide pin and air hose hole, see <a href="#">Mounting flange on page 35</a> .
4	For the gripper with a vacuum module, check the O-ring in the air hose hole. Replace if damaged.	O-ring 4x2: 3HAC063220-001 (1 pcs)  xx1500001625
5	Rotate the arm tool flange with the gripper to make one of the three screw holes accessible and then refit the screw.	Screw: M2.5 x 8, 3HAC051701-001 (1 pcs)  xx1500001391
6	Rotate the flange with 180 degrees to access the opposite screw hole and then refit the screw.	Screw: M2.5 x 8, 3HAC051701-001 (1 pcs)  xx1500001392

Continues on next page

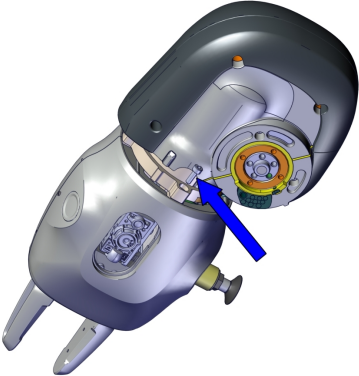

	Action	Note
7	Rotate the flange with 90 degrees to access the last screw hole and then refit the screw.	<p>Screw: M2.5 x 8, 3HAC051701-001 (1 pcs)</p>  <p>xx1500001393</p>
8	Turn on the power and air supply to the gripper and then perform commissioning on the gripper.	

## 4 Repair

### 4.6 Replacing the camera

### 4.6 Replacing the camera

#### Location of the camera

The camera is located as shown in the figure.

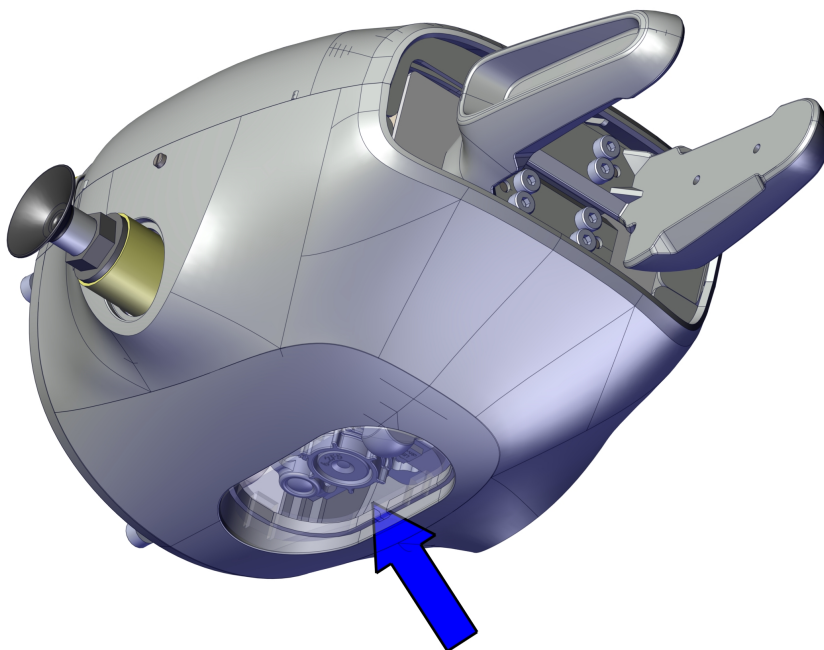

xx150000611

#### Required tools

Equipment	Article number	Note
Standard toolkit	-	Content is defined in section <a href="#">Standard toolkit on page 155</a> .

#### Required spare parts

Spare part	Article number	Note
Camera AE3	3HAC051676-001	
Hex socket head cap screw	3HAC051700-001	M2x7, class 8.8
FFC for camera	3HAC054157-002	31 pin; 76-mm length



*Continues on next page*

Removing the camera

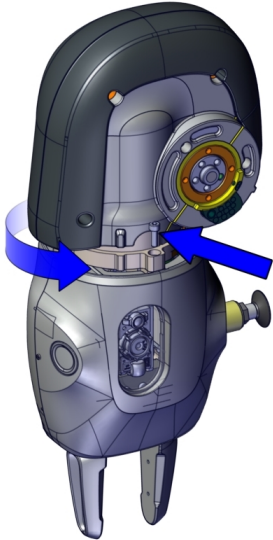
Removing the whole gripper

	Action	Note
1	 <b>CAUTION</b> Do not install or remove the gripper when power is on. Otherwise damage to the electronics may occur.  Always check the gripper power status before commencing any service work. Make sure that all supplies for electrical power and air pressure are turned off.	For details about how to check the power status and how to turn off gripper power using FlexPendant, see <a href="#">Configuration page on page 48</a> .
2	Rotate the arm tool flange on the axis 6 of the robot to make one of the three screw holes accessible, and then remove the screw.	  xx1500001390
3	Repeat the preceding step to remove the other two screws to detach the whole gripper from the arm tool flange.	

Removing the filter and suction cup

	Action	Note/Illustration
1	Twist and remove the filter and suction cup.   <b>Note</b> The filter and suction cup are provided as a set and recommended to be replaced together. A built-in screw is mounted on the filter, which enables a simple removal of filter and suction cup by just twisting them.	  xx1400002624  A Suction cup B Filter

Continues on next page

## 4 Repair

### 4.6 Replacing the camera

*Continued*

#### Removing the shell

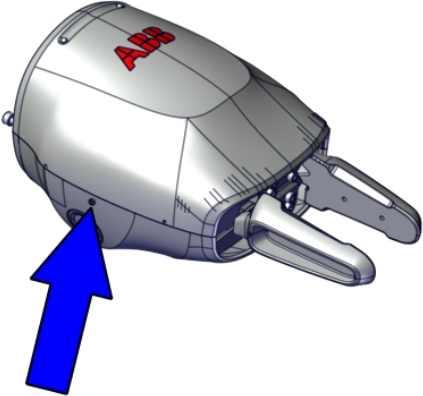
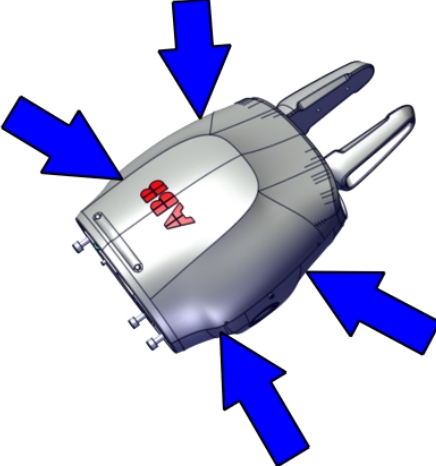
	Action	Note/Illustration
1	Remove the screws that fasten the shell.	 <p>xx150000759</p>
2	Press the locations shown in the figure gently to detach the shell. The shell consists of two parts: <ul style="list-style-type: none"><li>• lower shell</li><li>• upper shell</li></ul>	 <p>xx1400002152</p>

#### Removing the camera

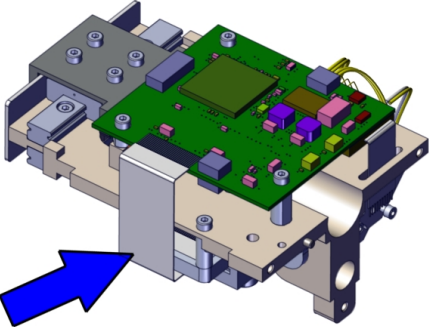
	Action	Note
1	Disconnect the FFC from the camera.	 <p>xx150000612</p>

*Continues on next page*

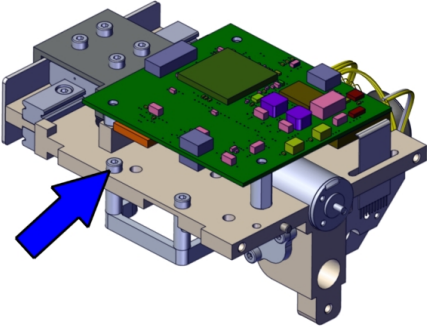
	Action	Note
2	Remove the screws to detach the camera with the camera bracket from the servo base.	 <p>xx150000614</p>

Refitting the camera

Refitting the camera

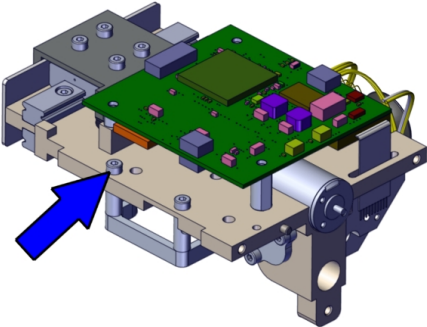
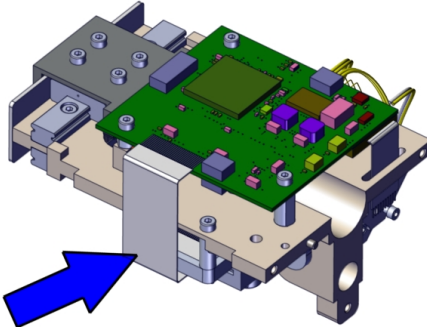
	Action	Note/Illustration
1	Refit the camera with the camera bracket to the servo base.	<p>Camera AE3, 3HAC051676-001 Hex socket head cap screw , 3HAC051700-001: M2x7, class 8.8 (2 pcs)</p>  <p>xx150000614</p>
2	Check the FFC for the camera. Replace if damaged.	FFC for camera, 3HAC054157-002
3	Connect the FFC to the camera.	 <p>xx150000612</p>

Continues on next page

## 4 Repair

### 4.6 Replacing the camera

*Continued*

#### Refitting the shell

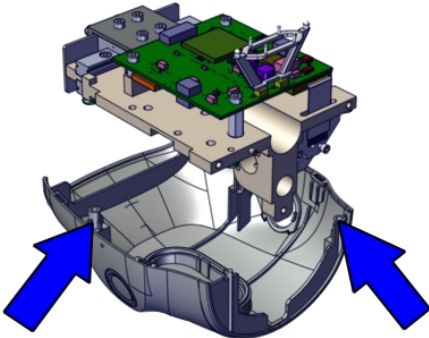
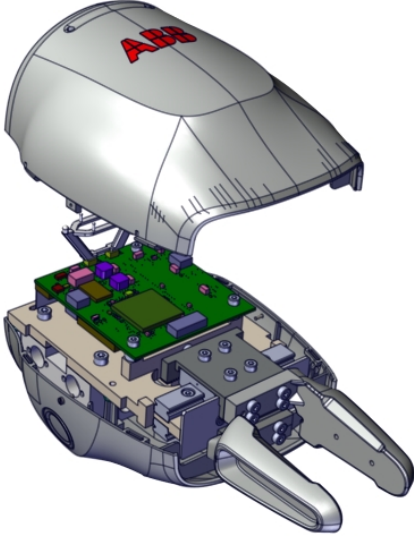
	Action	Note/Illustration
1	Put the lower shell to the base plate and insert the locating pins on the lower shell to the location holes on the base plate.	<p>Shell complete (with camera window), 3HAC066000-001</p> <p>Shell complete (without camera window), 3HAC066001-001</p>  <p>xx1400002155</p>
2	Put the upper shell to the base plate.	 <p>xx1500000769</p>
3	Press the lower shell and upper shell together.	

*Continues on next page*

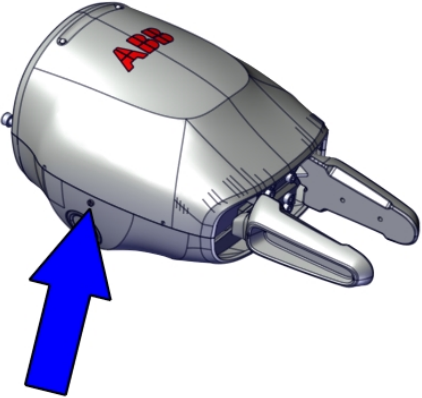
	Action	Note/Illustration
4	Refit the screws to fasten the shell.	<p>Screw M1.2 (2 pcs)</p>  <p>xx150000759</p>

Refit the filter and suction cup

	Action	Note/Illustration
1	Refit the filter and suction cup by twisting them.	<p>Vacuum filter , 3HAC047854-001 Vacuum rubber cup , 3HAC047927-001</p>  <p>xx1400002624</p> <p>A Suction cup B Filter</p>

Refitting the whole gripper

	Action	Note
1	<p> <b>CAUTION</b></p> <p>Do not install or remove the gripper when power is on. Otherwise damage to the electronics may occur.</p> <p>Always check the gripper power status before commencing any service work.. Make sure that all supplies for electrical power and air pressure are turned off.</p>	<p>For details about how to check the power status and how to turn off gripper power using FlexPendant, see <a href="#">Configuration page on page 48</a>.</p>

Continues on next page

## 4 Repair

### 4.6 Replacing the camera

Continued

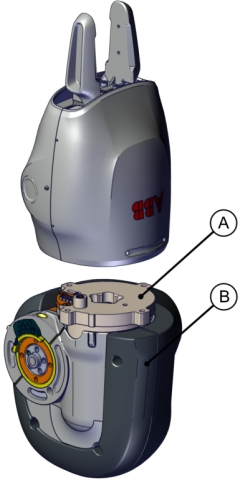
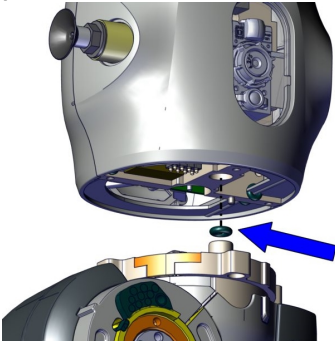
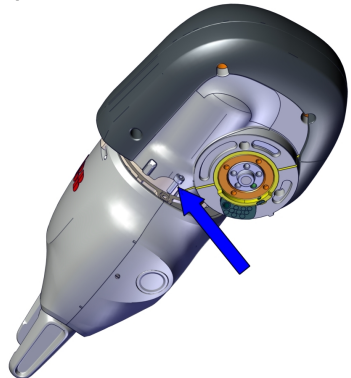
	Action	Note
2	Position the gripper to the arm tool flange on the axis 6 of the robot.	 <p>xx1500001394</p> <p>A Arm tool flange B Axis 6 of the robot</p>
3	Use the guide pin and air hose hole to make the gripper align with the arm tool flange.	For the positions of the guide pin and air hose hole, see <a href="#">Mounting flange on page 35</a> .
4	For the gripper with a vacuum module, check the O-ring in the air hose hole. Replace if damaged.	<p>O-ring 4x2: 3HAC063220-001 (1 pcs)</p>  <p>xx1500001625</p>
5	Rotate the arm tool flange with the gripper to make one of the three screw holes accessible and then refit the screw.	<p>Screw: M2.5 x 8, 3HAC051701-001 (1 pcs)</p>  <p>xx1500001391</p>

Continues on next page

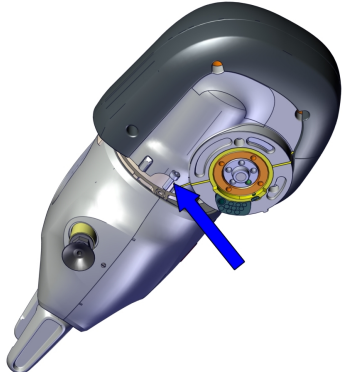
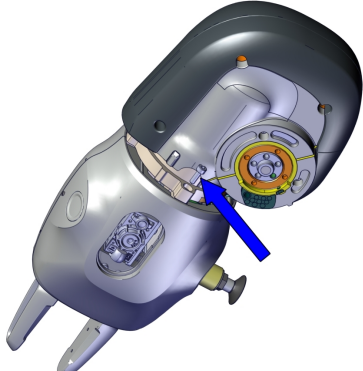

	Action	Note
6	Rotate the flange with 180 degrees to access the opposite screw hole and then refit the screw.	<p>Screw: M2.5 x 8, 3HAC051701-001 (1 pcs)</p>  <p>xx1500001392</p>
7	Rotate the flange with 90 degrees to access the last screw hole and then refit the screw.	<p>Screw: M2.5 x 8, 3HAC051701-001 (1 pcs)</p>  <p>xx1500001393</p>
8	Turn on the power and air supply to the gripper and then perform commissioning on the gripper.	

## 4 Repair

### 4.7 Replacing the servo base

### 4.7 Replacing the servo base

#### Location of the servo base

The servo base is located as shown in the figure.

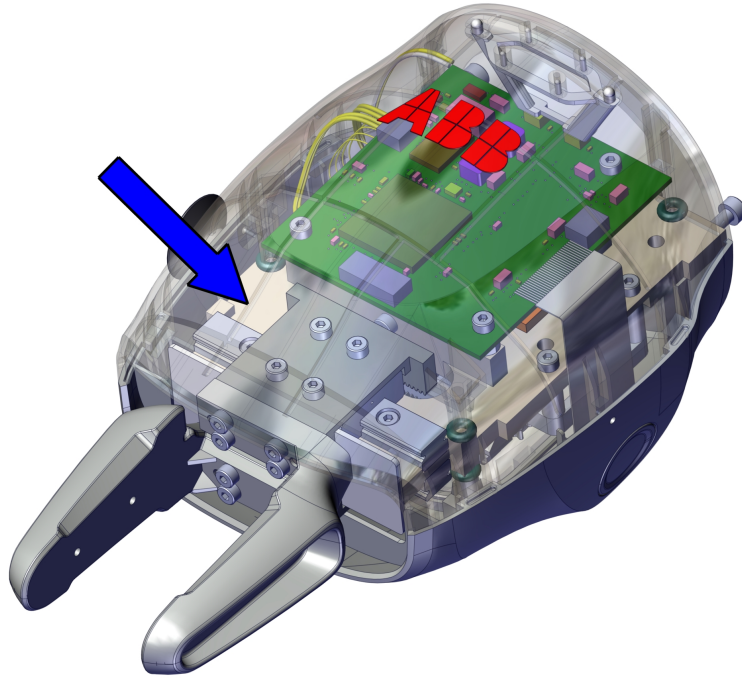

xx1400002623

#### Required tools

Equipment	Article number	Note
Standard toolkit	-	Content is defined in section <a href="#">Standard toolkit on page 155</a> .

#### Required spare parts

Spare part	Article number	Note
Servo base	3HAC065996-001	



*Continues on next page*

Removing the servo base

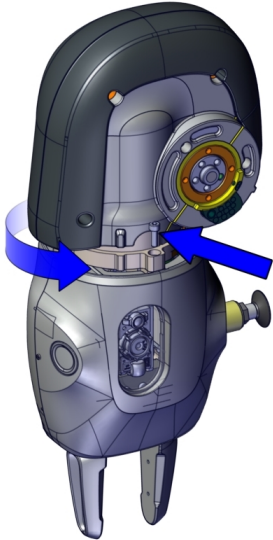
Removing the whole gripper

	Action	Note
1	 <b>CAUTION</b> Do not install or remove the gripper when power is on. Otherwise damage to the electronics may occur. Always check the gripper power status before commencing any service work. Make sure that all supplies for electrical power and air pressure are turned off.	For details about how to check the power status and how to turn off gripper power using FlexPendant, see <a href="#">Configuration page on page 48</a> .
2	Rotate the arm tool flange on the axis 6 of the robot to make one of the three screw holes accessible, and then remove the screw.	 xx1500001390
3	Repeat the preceding step to remove the other two screws to detach the whole gripper from the arm tool flange.	

Removing the filter and suction cup

	Action	Note/Illustration
1	Twist and remove the filter and suction cup.  <b>Note</b> The filter and suction cup are provided as a set and recommended to be replaced together. A built-in screw is mounted on the filter, which enables a simple removal of filter and suction cup by just twisting them.	 xx1400002624 A Suction cup B Filter

Continues on next page

## 4 Repair

### 4.7 Replacing the servo base

*Continued*

#### Removing the shell

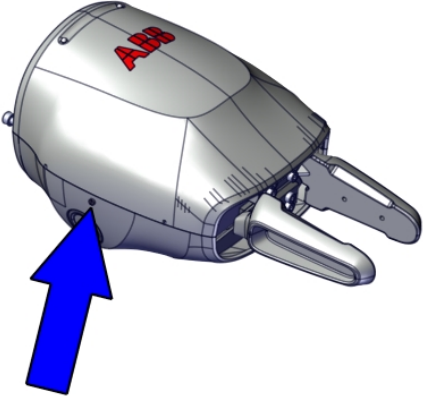
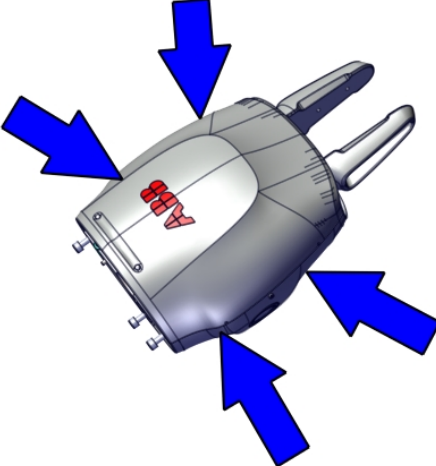
	Action	Note/Illustration
1	Remove the screws that fasten the shell.	 <p>xx150000759</p>
2	Press the locations shown in the figure gently to detach the shell. The shell consists of two parts: <ul style="list-style-type: none"><li>• lower shell</li><li>• upper shell</li></ul>	 <p>xx1400002152</p>

#### Removing the pneumatic block

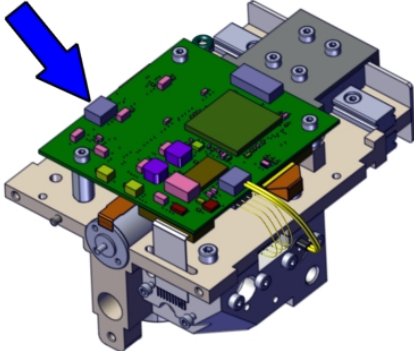
	Action	Note/Illustration
1	Disconnect the connectors from the vacuum sensor and valve.	 <p>xx1400002618</p>

*Continues on next page*

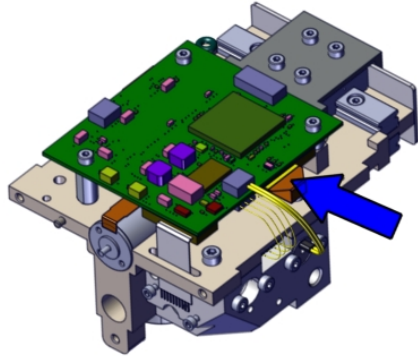
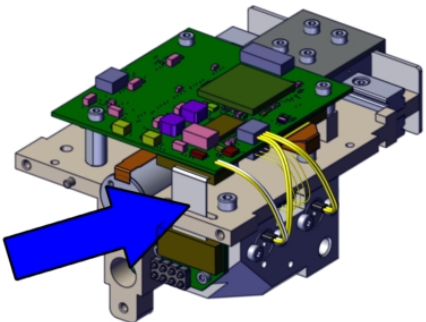
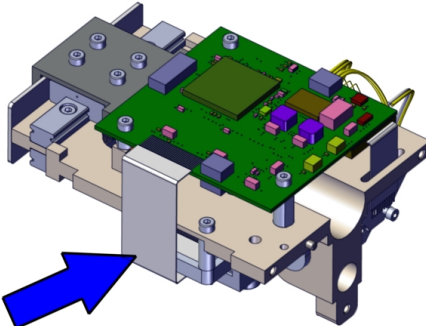
	Action	Note/Illustration
2	Disconnect the motor cable.	 <p>xx1400002619</p>
3	For the left pneumatic block, disconnect the flexible cable for connector board.	 <p>xx1500000608</p>
4	For the gripper with a camera, disconnect the flexible flat cable (FFC) from the camera.	 <p>xx1500000612</p>

Continues on next page

## 4 Repair

### 4.7 Replacing the servo base

Continued

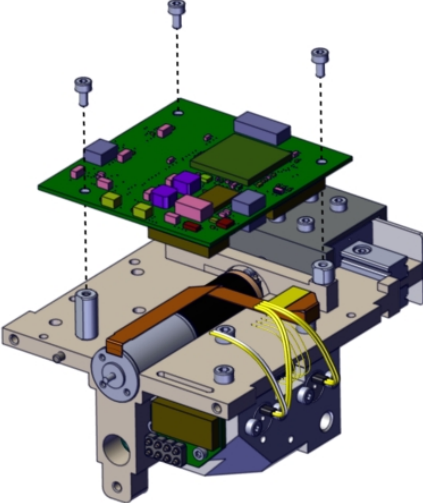
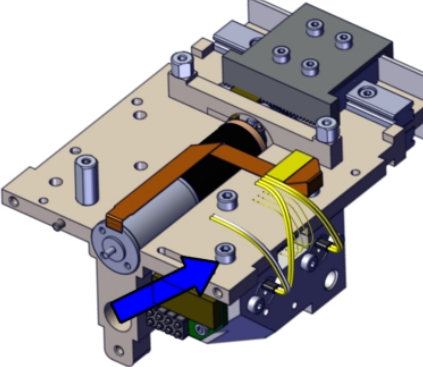
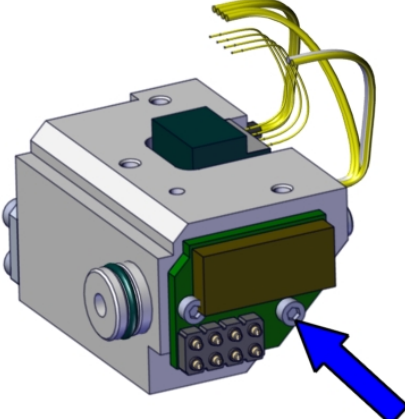
	Action	Note/Illustration
5	Remove the screws to detach the main PCB.	 <p>xx1400002621</p>
6	Remove the screws to detach the pneumatic block from the servo base.	 <p>xx1500000610</p>
7	For the left pneumatic block, remove the screws to remove the connector board.	 <p>xx1500000609</p>

Continues on next page

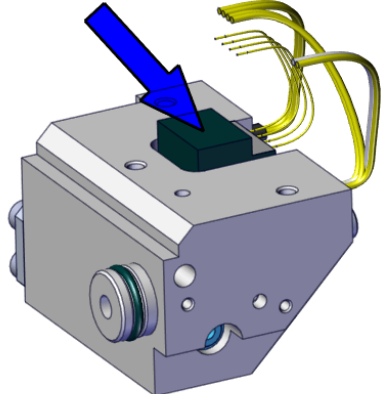
	Action	Note/Illustration
8	Remove the vacuum sensor.	 <p data-bbox="989 750 1093 772">xx210000696</p>

Removing the camera

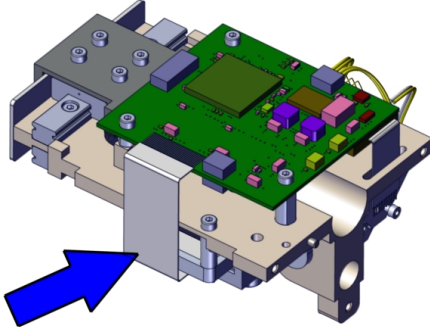
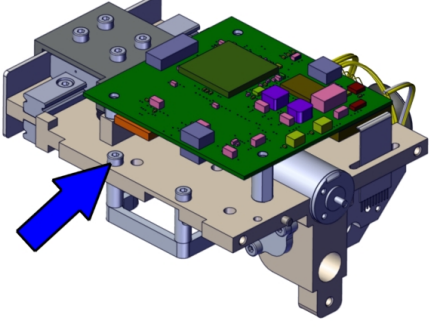
	Action	Note
1	Disconnect the FFC from the camera.	 <p data-bbox="989 1265 1093 1288">xx150000612</p>
2	Remove the screws to detach the camera with the camera bracket from the servo base.	 <p data-bbox="989 1668 1093 1691">xx150000614</p>

Continues on next page

## 4 Repair

### 4.7 Replacing the servo base

*Continued*

#### Refitting the servo base

#### Refitting the camera

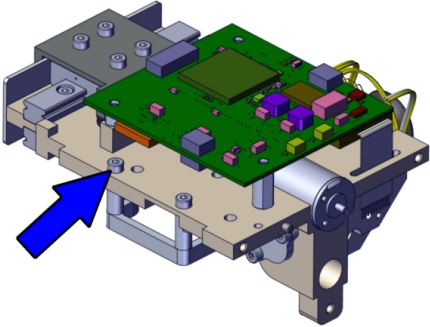
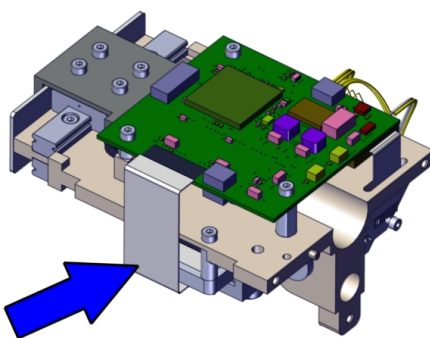
	Action	Note/Illustration
1	Refit the camera with the camera bracket to the servo base.	Camera AE3, 3HAC051676-001 Hex socket head cap screw , 3HAC051700-001: M2x7, class 8.8 (2 pcs)  xx150000614
2	Check the FFC for the camera. Replace if damaged.	FFC for camera, 3HAC054157-002
3	Connect the FFC to the camera.	 xx150000612

#### Refitting the pneumatic block

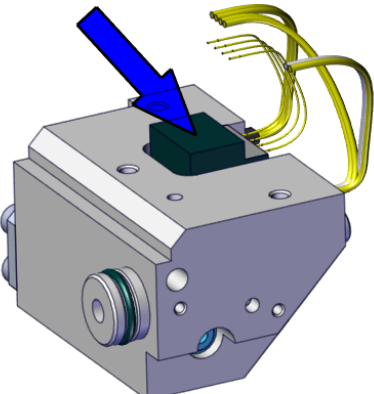
	Action	Note/Illustration
1	Refit the vacuum sensor.	Vacuum sensor, 3HAC047823-001  xx210000696

*Continues on next page*

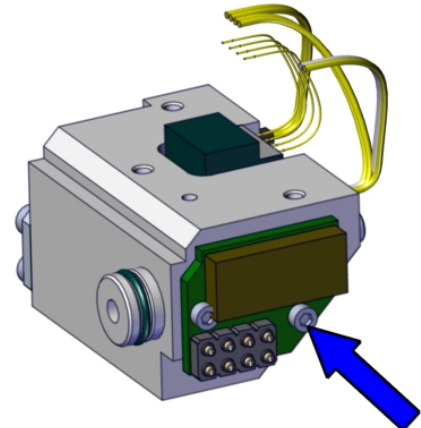
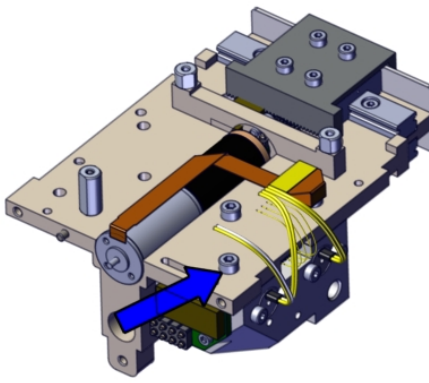
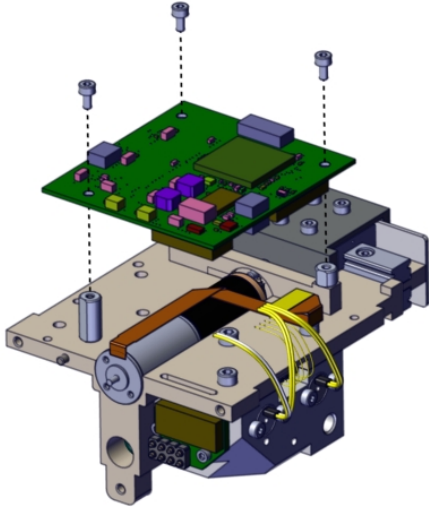

Action	Note/Illustration
2	<p>For the left pneumatic block, refit the connector board with screws.</p> <p>Pneumatic block connector board, 3HAC051609-001</p>  <p>xx150000609</p>
3	<p>Refit the new pneumatic block to the servo base with screws.</p> <p>Screw M2.5 (3 pcs)                      Pneumatic block, 3HAC054989-001                      Pneumatic block, 3HAC054990-001</p>  <p>xx150000610</p>
4	<p>Refit the main PCB.</p>  <p>xx1400002621</p>

Continues on next page

## 4 Repair

### 4.7 Replacing the servo base

*Continued*

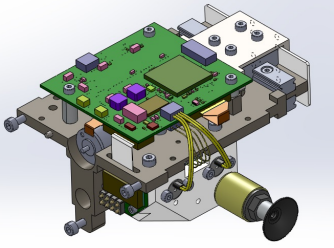
	Action	Note/Illustration
5	Check the FFC for the pneumatic block connector board and FFC for the camera. Replace if damaged.	FFC for pneumatic block connector board, 3HAC051610-002 FFC for camera, 3HAC054157-002
6	Reconnect the connectors: <ul style="list-style-type: none"><li>• Vacuum sensor and valve</li><li>• motor cable</li><li>• FFC for the pneumatic block connector board</li><li>• FFC for the camera</li></ul>	 xx1400002628

### Refitting the shell

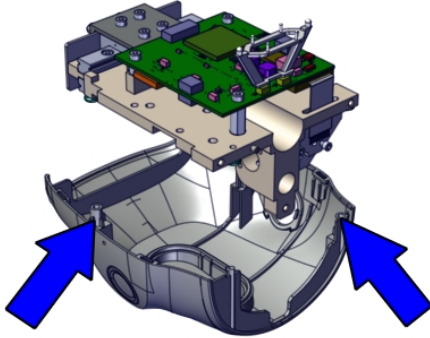
	Action	Note/Illustration
1	Put the lower shell to the base plate and insert the locating pins on the lower shell to the location holes on the base plate.	Shell complete (with camera window), 3HAC066000-001 Shell complete (without camera window), 3HAC066001-001  xx1400002155

*Continues on next page*

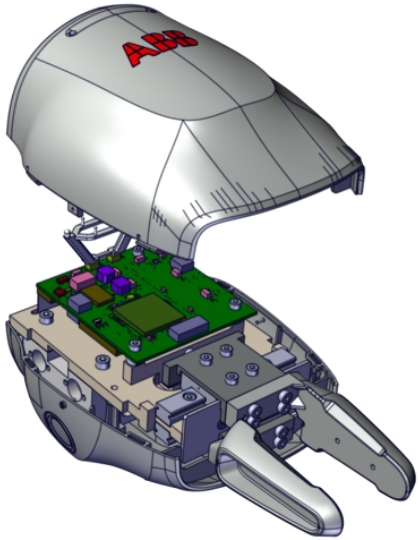
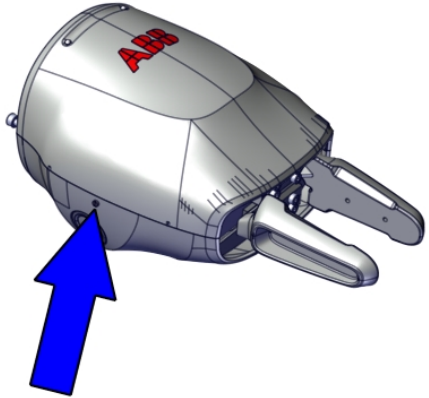
	Action	Note/Illustration
2	Put the upper shell to the base plate.	 <p>xx150000769</p>
3	Press the lower shell and upper shell together.	
4	Refit the screws to fasten the shell.	<p>Screw M1.2 (2 pcs)</p>  <p>xx150000759</p>

Continues on next page

## 4 Repair

### 4.7 Replacing the servo base

*Continued*

#### Refit the filter and suction cup

	Action	Note/Illustration
1	Refit the filter and suction cup by twisting them.	Vacuum filter , 3HAC047854-001 Vacuum rubber cup , 3HAC047927-001    <small>xx1400002624</small>  A Suction cup B Filter

#### Refitting the whole gripper

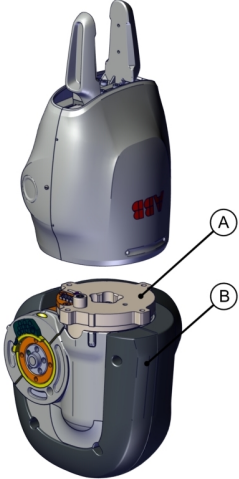
	Action	Note
1	 <b>CAUTION</b>  Do not install or remove the gripper when power is on. Otherwise damage to the electronics may occur.  Always check the gripper power status before commencing any service work.. Make sure that all supplies for electrical power and air pressure are turned off.	For details about how to check the power status and how to turn off gripper power using FlexPendant, see <a href="#">Configuration page on page 48</a> .
2	Position the gripper to the arm tool flange on the axis 6 of the robot.	  <small>xx1500001394</small>  A Arm tool flange B Axis 6 of the robot

*Continues on next page*

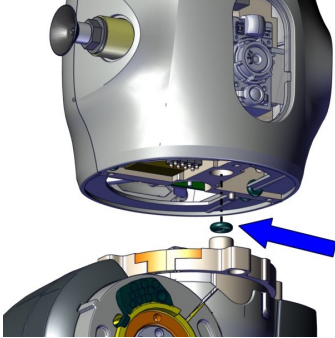
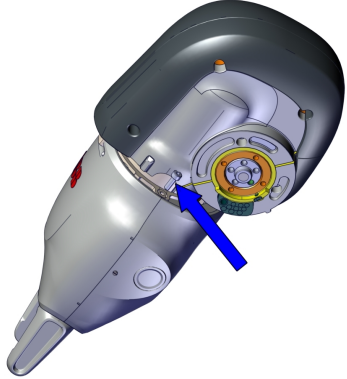
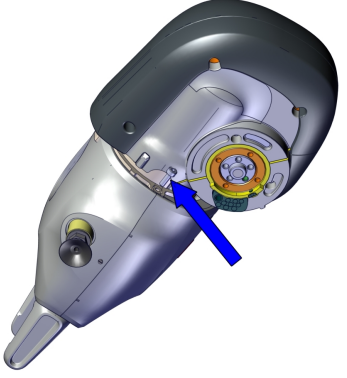
	Action	Note
3	Use the guide pin and air hose hole to make the gripper align with the arm tool flange.	For the positions of the guide pin and air hose hole, see <a href="#">Mounting flange on page 35</a> .
4	For the gripper with a vacuum module, check the O-ring in the air hose hole. Replace if damaged.	O-ring 4x2: 3HAC063220-001 (1 pcs)  <small>xx1500001625</small>
5	Rotate the arm tool flange with the gripper to make one of the three screw holes accessible and then refit the screw.	Screw: M2.5 x 8, 3HAC051701-001 (1 pcs)  <small>xx1500001391</small>
6	Rotate the flange with 180 degrees to access the opposite screw hole and then refit the screw.	Screw: M2.5 x 8, 3HAC051701-001 (1 pcs)  <small>xx1500001392</small>

*Continues on next page*

## 4 Repair

### 4.7 Replacing the servo base

*Continued*

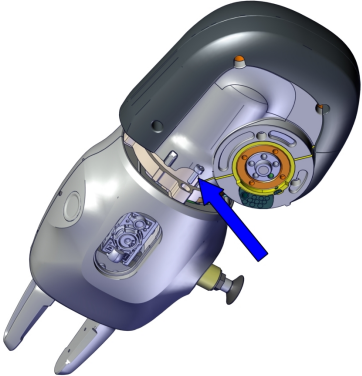
	Action	Note
7	Rotate the flange with 90 degrees to access the last screw hole and then refit the screw.	Screw: M2.5 x 8, 3HAC051701-001 (1 pcs)  xx1500001393
8	Turn on the power and air supply to the gripper and then perform commissioning on the gripper.	

## 5 RAPID references

### 5.1 Overview

#### RAPID instruction/function naming

A shorter name is introduced to each RAPID instruction/function, such as, `g_Init` corresponding to the original `Hand_Intialize`. The shorter and longer names of a RAPID instruction/function are totally compatible to each other, that is, having the same usage, arguments and syntax.

The longer names may become invalid in a short future. Users are recommended to use the shorter names that are also easy to remember and use. If the users continue using the longer instruction/function name, the following notification will be displayed to prompt the using of newly shorter ones.

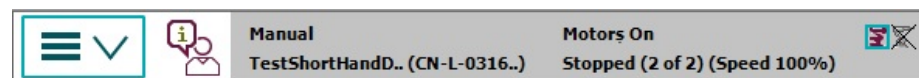

#### Event Log - Event Message

Event Message 41544

2016-08-25 08:49:39



#### Obsolete Instruction

Description

Task: T\_ROB\_R

The procedure `Hand_Initialize` is obsolete. It will work for now, but might be removed in a later release. Use `g_Init` instead and you will have the same functionality.

Program Ref. `/HandDriver/g_Init/report_obsolete_proc/258`

Next

Previous

OK

xx1600001269

*Continues on next page*

## 5 RAPID references

### 5.1 Overview

Continued

#### Program execution on virtual controller

If the following instruction/function is executed on the virtual controller,	Then,
<ul style="list-style-type: none"><li>• g_Init</li><li>• g_JogIn</li><li>• g_JogOut</li><li>• g_MoveTo</li><li>• g_GripIn</li><li>• g_GripOut</li><li>• g_Calibrate</li><li>• g_Stop</li><li>• g_SetMaxSpd</li><li>• g_SetForce</li><li>• g_BlowOn1</li><li>• g_BlowOn2</li><li>• g_BlowOff1</li><li>• g_BlowOff2</li></ul>	the program execution returns immediately to the calling procedure. In this case, the gripper performs no action and no error reports.
<ul style="list-style-type: none"><li>• g_VacuumOn1</li><li>• g_VacuumOn2</li><li>• g_VacuumOff1</li><li>• g_VacuumOff2</li></ul>	the program execution returns HIGH after turning on the vacuum channel and returns LOW after turning off the vacuum channel.
<ul style="list-style-type: none"><li>• g_GetPos</li><li>• g_GetSpd</li><li>• g_GetErrID</li><li>• g_GetState</li></ul>	the program execution returns 0.
<ul style="list-style-type: none"><li>• g_GetPressure1</li><li>• g_GetPressure2</li></ul>	the program execution returns 0 if the vacuum channel was turned on before by using g_VacuumOn1 or g_VacuumOn2 and returns 100 if the vacuum channel was turned off before by using g_VacuumOff1 or g_VacuumOff2 . g_GetPressure1 is for the first pneumatic module and g_GetPressure2 is for the second pneumatic module.
<ul style="list-style-type: none"><li>• g_IsCalibrated</li><li>• g_isCamOnline</li></ul>	the program execution returns FALSE.



## 5.2 Instructions

### 5.2.1 RAPID instructions for grippers

#### 5.2.1.1 g\_Init - Initialize the gripper

---

##### Usages

`g_Init` (replacing the original `Hand_Intialize`) is used to initialize the gripper with optionally specified values. For the values that are not specified, the default values will be used.

This instruction can be called before all other gripper-related statements.

---

##### Basic examples

###### Example 1

```
g_Init \maxSpd := 20, \holdForce := 10;
```

In this example, the gripper will be initiated with a maximum speed of 20 mm/s and a holding force of 10 N.

###### Example 2

```
g_Init \Calibrate;
```

In this example, the gripper will be initiated with default parameter values. The argument `Calibrate` is used to close the fingers and then perform a calibration without holding force.

###### Example 3

```
g_Init \Calibrate, \Grip;
```

In this example, the gripper will be initiated with default parameter values. The argument `Grip` is used to close the fingers and then perform a calibration with the default holding force of 20 N.

---

##### Arguments

```
g_Init [\maxSpd] [\holdForce] [\phyLimit] [\Calibrate] [\Grip]
```

`[\maxSpd]`

**Data type:** num

The gripper's maximum allowed speed in unit of mm/s. If it is not set, the default maximum speed 25 mm/s will be used.

`[\holdForce]`

**Data type:** num

The gripper's expected force in unit of N when gripping and holding the target object. If this is not set, the default force 20 N will be used.

`[\phyLimit]`

**Data type:** num

*Continues on next page*

## 5 RAPID references

---

### 5.2.1.1 g\_Init - Initialize the gripper

*Continued*

Sometimes, the gripper works in a smaller travel range than the recommended value 25 mm. Given this argument, the system will use the value to determine the maximum possible travel range of the gripper.

The value should be within 0-25 mm. If it is not set, the default value 25 will be used.

`[\Calibrate]`

**Data type:** `switch`

If this argument is declared, the gripper will undergo a calibrating process without holding force. Note that the gripper will move inward to the limit first.

`[\Grip]`

**Data type:** `switch`

If this argument is declared, the gripper will undergo a calibrating process with the default holding force of 20 N. Note that the gripper will move inward to the limit first.

This argument is always used together with the argument `[\Calibrate]`.

---

### Limitations

This instruction is allowed only in gripper tasks `T_ROB_R` and `T_ROB_L`.

---

### Program execution

If `Calibrate` or `[\Grip]` is declared, the program will pause until the calibration process is completed.

---

### Syntax

```
g_Init
  ['\ maxSpd :='] <expression (IN) of num> ','
  ['\ holdForce :='] <expression (IN) of num> ','
  ['\ phyLimit :='] <expression (IN) of num> ','
  ['\ Calibrate ] ','
  ['\ Grip ] ';'
;
```

#### 5.2.1.2 g\_JogIn - Jog the gripper to move inward

---

##### Usages

`g_JogIn` (replacing the original `Hand_JogInward`) is used to move the gripper inward, and does not stop until reaching a mechanical limit or timeout.

---

##### Basic examples

```
g_JogIn;
```

---

##### Limitations

This instruction is allowed only in gripper tasks `T_ROB_R` and `T_ROB_L`.

---

##### Program execution

The program will pause until the gripper reaches a mechanical limit or timeout. Even if the gripper is stuck mechanically, no error or warning is raised and the program execution will go on.

---

##### Syntax

```
g_JogIn ' ; '
```

## 5 RAPID references

---

### 5.2.1.3 g\_JogOut - Jog the gripper to move outward

#### 5.2.1.3 g\_JogOut - Jog the gripper to move outward

---

##### Usages

`g_JogOut` (replacing the original `Hand_JogOutward`) is used to move the gripper outward, and does not stop until reaching a mechanical limit or timeout.

---

##### Basic examples

```
g_JogOut ;
```

---

##### Limitations

This instruction is allowed only in gripper tasks `T_ROB_R` and `T_ROB_L`.

---

##### Program execution

The program will pause until the gripper reaches a mechanical limit or timeout. Even if the gripper is stuck mechanically, no error or warning is raised and the program execution will go on.

---

##### Syntax

```
g_JogOut ' ; '
```

---

### 5.2.1.4 g\_MoveTo - Move the gripper to a target position

---

#### Usages

`g_MoveTo` (replacing the original `Hand_MoveTo`) is used to move the gripper to a specified position and requires that the gripper must have been calibrated.

---

#### Basic examples

##### Example 1

```
g_MoveTo 15;
```

In this example, the gripper will move to the position that is 15 mm away from the calibrated zero point. The program will pause until the movement is completed.

##### Example 2

```
g_MoveTo 20, \NoWait;
```

In this example, the gripper will move to the position that is 20 mm away from the calibrated zero point. However, the program will continue to the next statement regardless of whether the movement has completed or not.

---

#### Arguments

```
g_MoveTo [targetPos] [\NoWait]
```

[targetPos]

**Data type:** num

The target position to which the gripper is specified to move with the unit of mm. The value should be within 0-25 mm or 0-`phyLimit` if `phyLimit` is set in `g_Init`.

[\NoWait]

**Data type:** switch

If `NoWait` is set, the program will continue to the next statement upon the sending of the command to the gripper, regardless of whether the movement has completed or not.

---

#### Limitations

This instruction is allowed only in gripper tasks `T_ROB_R` and `T_ROB_L`.

---

#### Program execution

If `NoWait` is not set, the program will pause for the movement to complete or raise an error when the movement is not completed within the given time 5 seconds.

If `NoWait` is set, the program will go directly to the next statement regardless of the movement status. However, the program may need to check the movement result later.

If the specified distance is too small, for example, less than 0.2 mm, the gripper will not move.

*Continues on next page*

## 5 RAPID references

---

### 5.2.1.4 g\_MoveTo - Move the gripper to a target position

*Continued*

---

#### Error handling

If the gripper is not calibrated, an error is raised and the system variable `ERRNO` will be set to `ERR_HAND_NOTCALIBRATED`. The error can be handled in the error handler.

If the gripper does not reach the specified target position within the given time 5 seconds, or the movement is mechanically blocked before reaching the target position, an error is raised and the system variable `ERRNO` will be set to `ERR_HAND_FAILEDMOVEPOS`. The error can be handled in the error handler. If `NoWait` is set, `ERR_HAND_FAILEDMOVEPOS` will not be raised.

If the robot loses the communication with the gripper, the error `ERR_NORUNUNIT` will be raised.

---

#### Syntax

```
g_MoveTo
  [targetPos ':='] <expression (IN) of num> ', '
  ['\ ' NoWait ] ';'

```

### 5.2.1.5 g\_GripIn - Jog the gripper to grip inward

#### Usages

`g_GripIn` (replacing the original `Hand_GripInward`) is used to indicate the gripper to grip inward and requires that the gripper must be calibrated.

#### Basic examples

##### Example 1

```
g_GripIn;
```

In this example, the gripper will try to grip inward with the default force. If there is no object, the two fingers of the gripper will move together and press each other tightly.

##### Example 2

```
g_GripIn \holdForce := 15;
```

In this example, the gripper is instructed to grip the target object with a 15 N force.

##### Example 3

```
g_GripIn \holdForce :=15, \ targetPos := 10;
```

In this example, the gripper will try to successfully grip around the particular point (10 mm) with a 15 N force. If the gripper does not touch any object in that point, an error is raised.

##### Example 4

```
g_GripIn \ targetPos:=5, \ posAllowance := 1;
```

In this example, the gripper will try to successfully grip around the particular point (5 mm) with the default force. The gripping position should be at  $5 \pm 1$  mm. Otherwise, an error is raised.

##### Example 5

```
g_GripIn \NoWait;
```

In this example, the gripper will directly grip inward with the default force. Instead of waiting for the completion of gripping, the RAPID program will go to the next statement directly after sending out the gripping command.

In this case, the user should check the completion of gripping operation themselves. This argument is used to achieve a fast gripping operation without any lag in robot moving. For details, see example 6.

##### Example 6

```

BOOL GripSuccess:=FALSE;
BOOL GripEvaluated :=FALSE;
MoveL Offs(GripPosition,0,0,50), z10
MoveLSync Offs(GripPosition,0,0,5), z0,"CloseHand";
MoveL GripPosition,z0;
MoveLSync Offs(GripPosition,0,0,50), z10,"EvaluateGrip";
MoveL GripComple, z10
Waituntil GripEvaluated;
IF GripSuccess THEN
! go on with next step.
```

*Continues on next page*

## 5 RAPID references

---

### 5.2.1.5 g\_GripIn - Jog the gripper to grip inward

*Continued*

```
ELSE
  ! retry to pick the part.
ENDIF
PROC CloseHand()
g_GripIn\NoWait;
ENDPROC
PROC EvaluateGrip()
WaitUnit Hand_GetActualSpd(=0;
IF Hand_GetActualPos() > 10 AND Hand_GetActualPos()<12 THEN
GripSuccess:=TRUE;
ELSE
GripSuccess:=FALSE;
ENDIF
GripEvaluated:=TRUE;
ENDPROC
```

In this example, the gripping operation will be executed as an interrupt. That means that even a continuous robot moving without fine point pause is allowed here. After the gripping operation, the program will check whether this gripping is successfully performed.

---

#### Arguments

`g_GripIn` [`\holdForce`] [`\targetPos`] [`posAllowance`][`\NoWait`]

[`\holdForce`]

**Data type:** num

The force used by the gripper to hold the object. The value should be within 0-20 N. If this argument is not assigned, the default value 20 N will be used.

[`\targetPos`]

**Data type:** num

If `targetPos` is set but the gripper does not touch any object within the range from `targetPos-posAllowance` to `targetPos+posAllowance`, an error is raised.

The value should be within 0-25 mm.

[`posAllowance`]

**Data type:** num

Ignored if `targetPos` is not set.

If `targetPos` is set but `posAllowance` is not, the default value 2 will be used.

[`\NoWait`]

Without this argument, the program will wait until a completion or failure of gripping operation.

If this argument is declared, the program will go to the next statement directly regardless of how the gripping will be executed.

---

#### Limitations

This instruction is allowed only in gripper tasks T\_ROB\_R and T\_ROB\_L.

*Continues on next page*



---

#### Program execution

If `NoWait` is not declared, the program will pause until the gripper holds the object successfully. Otherwise, an error is raised. If `NoWait` is declared, the call to this instruction will be ended and the program will directly go to the next statement.

If no detection is required, both `targetPos` and `posAllowance` can be omitted.

The gripping is supposed to last less than 5 minutes in normal operations. To avoid overheating of the gripper and other impacts caused by a long time of continuous gripping, the gripping force will be released automatically after an uninterrupted gripping for 30 minutes.

---

#### Error handling

If the gripper is not calibrated, an error is raised and the system variable `ERRNO` will be set to `ERR_HAND_NOTCALIBRATED`. The error can be handled in the error handler.

If the gripper is not in an expected state, an error is raised and the system variable `ERRNO` will be set to `ERR_HAND_WRONGSTATE`. The error can be handled in the error handler.

If `targetPos` is set but the object is not held within the expected range, an error is raised and the system variable `ERRNO` will be set to `ERR_HAND_FAILEDGRIPPOS`. The error can be handled in the error handler.

If `targetPos` is set to a larger value than the current position, the gripper cannot grip with an inward force. Then, an error is raised and the system variable `ERRNO` will be set to `FAILEDGRIPINWARD`. The error can be handled in the error handler.

---

#### Syntax

```
g_GripIn
  ['\ ' holdForce ':='] <expression (IN) of num> ', '
  ['\ ' targetPos ':='] <expression (IN) of num> ', '
  ['\ ' posAllowance ':='] <expression (IN) of num> ', '
  ['\ ' NoWait ] ';' ;
```

## 5 RAPID references

---

### 5.2.1.6 g\_GripOut - Jog the gripper to grip outward

#### 5.2.1.6 g\_GripOut - Jog the gripper to grip outward

---

##### Usages

`g_GripOut` (replacing the original `Hand_GripOutward`) is used to indicate the gripper to grip outward and requires that the gripper must be calibrated.

---

##### Basic examples

###### Example 1

```
g_GripOut;
```

In this example, the gripper will try to grip outward with the default force. If there is no object to grip, the two fingers of the gripper will press tightly against the mechanic limits.

###### Example 2

```
g_GripOut \holdForce := 15;
```

In this example, the gripper is instructed to grip the target object with a 15 N outward force.

###### Example 3

```
g_GripOut \holdForce :=15, \targetPos := 10;
```

In this example, the gripper will try to successfully grip around the particular point (10 mm) with a 15 N force. If the gripper does not touch any object in that point, an error is raised.

###### Example 4

```
g_GripOut \targetPos:=5, \posAllowance := 1;
```

In this example, the gripper will try to successfully grip around the particular point (5 mm) with the default outward force. The gripping position should be at  $5\pm 1$  mm. Otherwise, an error is raised.

###### Example 5

```
g_GripOut \NoWait;
```

In this example, the gripper will directly grip outward with the default force. Instead of waiting for the completion of gripping, the RAPID program will go to the next statement directly after sending out the gripping command.

In this case, the user should check the completion of gripping operation themselves. This argument is used to achieve a fast gripping operation without any lag in robot moving. For details, see example 6.

###### Example 6

```
BOOL GripSuccess:=FALSE;  
BOOL GripEvaluated :=FALSE;  
MoveL Offs(GripPosition,0,0,50), z10  
MoveLSync Offs(GripPosition,0,0,5), z0,"CloseHand";  
MoveL GripPosition,z0;  
MoveLSync Offs(GripPosition,0,0,50), z10,"EvaluateGrip";  
MoveL GripComple, z10  
Waituntil GripEvaluated;  
IF GripSuccess THEN
```

*Continues on next page*

5.2.1.6 g\_GripOut - Jog the gripper to grip outward  
*Continued*

```

! go on with next step.
ELSE
! retry to pick the part.
ENDIF
PROC CloseHand()
g_GripOut\NoWait;
ENDPROC
PROC EvaluateGrip()
WaitUnit Hand_GetActualSpd(=0;
IF Hand_GetActualPos() > 10 AND Hand_GetActualPos()<12 THEN
GripSuccess:=TRUE;
ELSE
GripSuccess:=FALSE;
ENDIF
GripEvaluated:=TRUE;
ENDPROC

```

In this example, the gripping operation will be executed as an interrupt. That means that even a continuous robot moving without fine point pause is allowed here. After the gripping operation, the program will check whether this gripping is successfully performed.

**Arguments**

```
g_GripOut [\holdForce] [\targetPos] [\posAllowance][\NoWait]
```

[\holdForce]

**Data type:** num

The force used by the gripper to hold the object. The value should be within 0-20 N. If this argument is not assigned, the default value 20 N will be used.

[\targetPos]

**Data type:** num

If **targetPos** is set but the gripper does not touch any object within the range from **targetPos-posAllowance** to **targetPos+posAllowance**, an error is raised.

The value should be within 0-25 mm.

[\posAllowance]

**Data type:** num

Ignored if **targetPos** is not set.

If **targetPos** is set but **posAllowance** is not, the default value 2 will be used.

[\NoWait]

Without this argument, the program will wait until a completion or failure of gripping operation.

If this argument is declared, the program will go to the next statement directly regardless of how the gripping will be executed.

**Limitations**

This instruction is allowed only in gripper tasks T\_ROB\_R and T\_ROB\_L.

*Continues on next page*

## 5 RAPID references

---

### 5.2.1.6 g\_GripOut - Jog the gripper to grip outward

*Continued*

---

#### Program execution

If `NoWait` is not declared, the program will pause until the gripper holds the object successfully. Otherwise, an error is raised. If `NoWait` is declared, the call to this instruction will be ended and the program will directly go to the next statement.

If no detection is required, both `targetPos` and `posAllowance` can be omitted.

The gripping is supposed to last less than 5 minutes in normal operations. To avoid overheating of the gripper and other impacts caused by a long time of continuous gripping, the gripping force will be released automatically after an uninterrupted gripping for 30 minutes.

---

#### Error handling

If the gripper is not calibrated, an error is raised and the system variable `ERRNO` will be set to `ERR_HAND_NOTCALIBRATED`. The error can be handled in the error handler.

If the gripper is not in an expected state, an error is raised and the system variable `ERRNO` will be set to `ERR_HAND_WRONGSTATE`. The error can be handled in the error handler.

If `targetPos` is set but the object is not held within the expected range, an error is raised and the system variable `ERRNO` will be set to `ERR_HAND_FAILEDGRIPPOS`. The error can be handled in the error handler.

If `targetPos` is set to a smaller value than the current position, the gripper cannot grip with an outward force. Then, an error is raised and the system variable `ERRNO` will be set to `FAILEDGRIPOUTWARD`. The error can be handled in the error handler.

---

#### Syntax

```
g_GripOut
  ['\ ' holdForce ':='] <expression (IN) of num> ', '
  ['\ ' targetPos ':='] <expression (IN) of num> ', '
  ['\ ' posAllowance ':='] <expression (IN) of num> ', '
  ['\ ' NoWait ] ';'

```

### 5.2.1.7 g\_Calibrate - Calibrate the gripper

#### Usages

`g_Calibrate` (replacing the original `Hand_DoCalibrate`) is used to calibrate the gripper in a particular position. Only after the gripper is calibrated, it can be instructed to perform movement or gripping.

#### Basic examples

##### Example 1

```
g_Calibrate;
```

In this example, the gripper will set the current position as the zero point.

##### Example 2

```
g_Calibrate \Jog;
```

In this example, the two fingers of the gripper will move together at the middle point first and then that point will be set as the zero point.

##### Example 3

```
g_Calibrate \Grip;
```

In this example, the gripper will undergo a calibrating process with the default holding force of 20 N and set the current position as the zero point.

#### Argument

```
[\Jog] [\Grip]
```

`[\Jog]`

**Data type:** `switch`

With this argument is declared, the gripper fingers will move to the middle point first and then that point will be set as the zero point.

`[\Grip]`

**Data type:** `switch`

If this argument is declared, the gripper will undergo a calibrating process with the default holding force of 20 N and set the current position as the zero point.

#### Limitations

This instruction is allowed only in gripper tasks `T_ROB_R` and `T_ROB_L`.

#### Program execution

The program does not continue to the next statement until the calibrating process is completed.

#### Syntax

```
g_Calibrate
  ['\ Jog] ','
  ['\ Grip] ';'
```

## 5 RAPID references

---

### 5.2.1.8 g\_Stop - Stop the gripper

### 5.2.1.8 g\_Stop - Stop the gripper

---

#### Usages

`g_Stop` (replacing the original `Hand_Stop`) is used to stop any action of the gripper. Especially, the motor will lose power.

---

#### Basic examples

```
g_Stop;
```

---

#### Program execution

The instruction will stop any movement or gripping operation of the gripper. Then, the program will continue.

---

#### Syntax

```
g_Stop ';' ;
```

---

### 5.2.1.9 g\_SetMaxSpd - Set the maximum speed

---

#### Usage

`g_SetMaxSpd` (replacing the original `Hand_SetMaxSpeed`) is used to set the maximum allowed speed of the gripper. Note that the actual maximum speed may be limited by the acceleration time.

---

#### Basic examples

```
g_SetMaxSpd 15;
```

In this example, the gripper is configured with a maximum allowed speed of 15 mm/s.

---

#### Arguments

```
g_SetMaxSpd maxSpd
```

`maxSpd`

**Data type:** num

The maximum allowed speed of the gripper in unit of mm/s.

The value should be within 0-25 mm/s.

---

#### Program execution

This instruction will give the gripper a new maximum speed. The new setting will be kept until you change it again or restart the robot system.

---

#### Error handling

If the robot loses the communication with the gripper, the error `ERR_NORUNUNIT` will be raised.

---

#### Syntax

```
g_SetMaxSpd  
[maxSpd ':='] <expression (IN) of num> ';' 
```

## 5 RAPID references

---

### 5.2.2.1 g\_BlowOn1 - Turn on blowing channel 1

## 5.2.2 RAPID instructions for pneumatic modules

### 5.2.2.1 g\_BlowOn1 - Turn on blowing channel 1

---

#### Usage

`g_BlowOn1` (replacing the original `Hand_TurnOnBlow1`) is used to turn on the blowing channel in gripper pneumatic module 1.

---

#### Basic examples

```
g_BlowOn1;
```

In this example, whether vacuum channel 1 is turned on will be inspected first and then is closed if necessary. Then, blow channel 1 will be turned on.

---

#### Program execution

The program will turn on the corresponding I/O signal. If there is no actual valve, this instruction has no meaning.

---

#### Syntax

```
g_BlowOn1 ';' ;
```



#### 5.2.2.2 g\_BlowOff1 - Turn off blowing channel 1

---

##### Usage

`g_BlowOff1` (replacing the original `Hand_TurnOffBlow1`) is used to turn off the blowing channel in gripper pneumatic module 1.

---

##### Basic examples

```
g_BlowOff1;
```

In this example, blow channel 1 will be turned off.

---

##### Program execution

The program will turn off the corresponding I/O signal. If there is no actual valve, this instruction has no meaning.

---

##### Syntax

```
g_BlowOff1 ';' ;'
```

## 5 RAPID references

---

### 5.2.2.3 g\_BlowOn2 - Turn on blowing channel 2

### 5.2.2.3 g\_BlowOn2 - Turn on blowing channel 2

---

#### Usage

`g_BlowOn2` (replacing the original `Hand_TurnOnBlow2`) is used to turn on the blowing channel in gripper pneumatic module 2.

---

#### Basic examples

```
g_BlowOn2;
```

In this example, whether vacuum channel 2 is turned on will be inspected first and then is closed if necessary. Then, blow channel 2 will be turned on.

---

#### Program execution

The program will turn on the corresponding I/O signal. If there is no actual valve, this instruction has no meaning.

---

#### Syntax

```
g_BlowOn2 ';' ;'
```

#### 5.2.2.4 g\_BlowOff2 - Turn off blowing channel 2

---

##### Usage

`g_BlowOff2` (replacing the original `Hand_TurnOffBlow2`) is used to turn off the blowing channel in gripper pneumatic module 2.

---

##### Basic examples

```
g_BlowOff2;
```

In this example, blow channel 2 will be turned off.

---

##### Program execution

The program will turn off the corresponding I/O signal. If there is no actual valve, this instruction has no meaning.

---

##### Syntax

```
g_BlowOff2 ';' ;'
```

## 5 RAPID references

---

### 5.2.2.5 g\_VacuumOn1 - Turn on vacuum channel 1

#### 5.2.2.5 g\_VacuumOn1 - Turn on vacuum channel 1

---

##### Usage

`g_VacuumOn1` (replacing the original `Hand_TurnOnVacuum1`) is used to turn on the vacuum channel in hand pneumatic module 1. After turning on the vacuum channel, the vacuum pressure in the pneumatic module will also be verified with the given threshold. If there is no enough vacuum, an error is raised.

---

##### Basic examples

###### Example 1

```
g_VacuumOn1;
```

In this example, whether blowing channel 1 is turned on will be checked first and then is closed if necessary. Then, vacuum channel 1 will be turned on.

###### Example 2

```
g_VacuumOn1 \threshold := 30;
```

After turning on the vacuum valve, the program will also read the vacuum pressure from the interior sensor. If the pressure is larger than 30 kpa, an error is raised.

---

##### Arguments

```
g_VacuumOn1 \threshold;
```

`\threshold`

**Data type:** num

Expected upper limit of the vacuum pressure. Normally, the value should be within 0-110 kpa.

---

##### Program execution

The program will turn on the corresponding I/O signal. It will also read the vacuum pressure from the interior sensor and compare it with the given threshold. The vacuum has 1s to reach the expected pressure.

---

##### Error handling

If `threshold` is set but the reading value of the pressure sensor is larger than the `threshold`, an error is raised and the system variable `ERRNO` will be set to `ERR_HAND_FAILEDVACUUM`. The error can be handled in the error handler.

---

##### Syntax

```
g_VacuumOn1  
[ '\ ' threshold ' := ' ] <expression (IN) of num> ';' ;
```

#### 5.2.2.6 g\_VacuumOff1 - Turn off vacuum channel 1

---

##### Usage

`g_VacuumOff1` (replacing the original `Hand_TurnOffVacuum1`) is used to turn off the vacuum channel in hand pneumatic module 1.

---

##### Basic examples

```
g_VacuumOff1;
```

In this example, vacuum channel 1 will be turned off.

---

##### Program execution

The program will turn off the corresponding I/O signal. If there is no actual valve, this instruction has no meaning.

---

##### Syntax

```
g_VacuumOff1 ';' ;'
```

## 5 RAPID references

---

### 5.2.2.7 g\_VacuumOn2 - Turn on vacuum channel 2

#### 5.2.2.7 g\_VacuumOn2 - Turn on vacuum channel 2

---

##### Usage

`g_VacuumOn2` (replacing the original `Hand_TurnOnVacuum2`) is used to turn is used to turn on the vacuum channel in hand pneumatic module 2. After turning on the vacuum channel, the vacuum pressure in the pneumatic module will also be verified with the given threshold. If there is no enough vacuum, an error is raised.

---

##### Basic examples

###### Example 1

```
g_VacuumOn2;
```

In this example, whether blowing channel 2 is turned on will be inspected first and then is closed if necessary. Then, vacuum channel 2 will be turned on.

###### Example 2

```
g_VacuumOn2 \threshold := 15;
```

After turning on the vacuum valve, the program will also read the vacuum pressure from the interior sensor. If the pressure is larger than 15 kpa, an error is raised.

---

##### Arguments

```
g_VacuumOn2 \threshold;
```

\threshold

**Data type:** num

Expected upper limit of the vacuum pressure. Normally, the value should be within 0-110 kpa.

---

##### Program execution

The program will turn on the corresponding I/O signal. It will also read the vacuum pressure from the interior sensor and compare it with the given threshold. The vacuum has 1s to reach the expected pressure.

---

##### Error handling

If threshold is set but the reading value of the pressure sensor is larger than the threshold, an error is raised and the system variable `ERRNO` will be set to `ERR_HAND_FAILEDVACUUM`. The error can be handled in the error handler.

---

##### Syntax

```
g_VacuumOn2  
['\' threshold ':='] <expression (IN) of num> ';' ;'
```

#### 5.2.2.8 g\_VacuumOff2 - Turn off vacuum channel 2

---

##### Usage

`g_VacuumOff2` (replacing the original `Hand_TurnOffVacuum2`) is used to turn off the vacuum channel in hand pneumatic module 1.  
is used to turn off the vacuum channel in hand pneumatic module 2.

---

##### Basic examples

```
g_VacuumOff2;
```

In this example, vacuum channel 2 will be turned off.

---

##### Program execution

The program will turn off the corresponding I/O signal. If there is no actual valve, this instruction has no meaning.

---

##### Syntax

```
g_VacuumOff2 ';' ;'
```

## 5 RAPID references

---

### 5.3.1.1 g\_IsCalibrated - Get gripper calibration status

## 5.3 Functions

### 5.3.1 RAPID functions for servo module

#### 5.3.1.1 g\_IsCalibrated - Get gripper calibration status

---

##### Usages

`g_IsCalibrated` (replacing the original `Hand_IsCalibrated`) is used to retrieve the calibration status of the gripper.

---

##### Basic examples

```
VAR bool isLeftHandCalibrated;  
isLeftHandCalibrated := g_IsCalibrated();
```

---

##### Returned value

**Data type:** `bool`

The function will return `TRUE` if the gripper has been calibrated, while `FALSE` if not calibrated.

---

##### Syntax

```
g_IsCalibrated '('  
  [ Value ':= ' ] <expression (IN) of num>  
' )'
```



---

### 5.3.1.2 g\_GetPos - Get current gripper position

---

#### Usages

`g_GetPos` (replacing the original `Hand_GetActualPos`) is used to retrieve the current position of the gripper, based on the previous calibrated zero point. Note that this result may have no sense if the gripper is not calibrated.

---

#### Basic examples

```
VAR num nLeftHandPos;  
nLeftHandPos:= g_GetPos();
```

---

#### Returned value

**Data type:** num

The function will return the value of the current position in unit of mm.

---

#### Error handling

If the communication to the corresponding gripper fails, the error `ERR_NORUNUNIT` will be raised.

If the gripper has not been calibrated, the error `ERR_NOTCALIBRATED` will be raised.

---

#### Syntax

```
g_GetPos '('  
  [ Value ':= ' ] <expression (IN) of num>  
' )'
```

## 5 RAPID references

---

### 5.3.1.3 g\_GetSpd - Get current gripper speed

#### 5.3.1.3 g\_GetSpd - Get current gripper speed

---

##### Usages

`g_GetSpd` (replacing the original `Hand_GetActualSpd`) is used to retrieve the current speed of the gripper.

---

##### Basic examples

```
VAR num nLeftHandSpd;  
nLeftHandSpd:= g_GetSpd();
```

---

##### Returned value

**Data type:** num

The function will return the value of the current speed in unit of mm/s.

---

##### Error handling

If the communication to the corresponding gripper fails, the error `ERR_NORUNUNIT` will be raised.

---

##### Syntax

```
g_GetSpd '('  
  [ Value ':= ' ] <expression (IN) of num>  
' )'
```

### 5.3.1.4 g\_GetState - Get current gripper status

#### Usages

`g_GetState` (replacing the original `Hand_GetFingerState`) is used to retrieve the current state of the gripper.

#### Basic examples

```
VAR num nLeftHandState;
nLeftHandState:= g_GetState();
```

#### Returned value

Data type: num

The function will return the value of the current state. The following table describes the gripper states.

Code	State	Description
0x0	Ready	The gripper is in free state and ready for receiving new commands.
0x1	Error	The gripper is in error state. Check what the error is based on the error ID. For details about the error IDs, see <a href="#">Error handling on page 145</a> .
0x2	Free_Move_Outward	The gripper is moving outward.
0x3	Free_Move_Inward	The gripper is moving inward.
0x4	Grip_Move_Inward	The gripper is moving inward and the movement stops only after the gripper reaches the target object or mechanical limit.
0x5	Grip_Move_Outward	The gripper is moving outward. The moving will stop only after the gripper reaches the target object or mechanical limit.
0x6	Action_Completed	The command is executed successfully.
0x7	Grip_Forcing_Inward	The gripper is adjusting its inward gripping force.
0x8	Grip_Forcing_Outward	The gripper is adjusting its outward gripping force.
0x9	Keep_Object	The gripper has completed the gripping operation and is holding the object.
0xA	Calibration	The gripper is under calibration.
0xB	Jog_Open	The gripper is jogged to move outward.
0xC	Jog_Close	The gripper is jogged to move inward.
0xF	Change_chirality	The gripper is changing the chirality (Left or Right).
0x10	Agile_Gripping_Inward	The gripper is moving inward with limited force (less than the assigned gripping force). The movement stops only after the gripper reaches the target object or mechanical limit.

*Continues on next page*

## 5 RAPID references

---

### 5.3.1.4 g\_GetState - Get current gripper status

*Continued*

Code	State	Description
0x11	Agile_Gripping_Outward	The gripper is moving outward with limited force (less than the assigned gripping force). The movement stops only after the gripper reaches the target object or mechanical limit.

---

#### Error handling

If the communication to the corresponding gripper fails, the error `ERR_NORUNUNIT` will be raised.

---

#### Syntax

```
g_GetState '('  
  [ Value ':= ' ] <expression (IN) of num>  
  ')'
```

### 5.3.1.5 g\_GetErrID - Get current gripper error ID

#### Usages

`g_GetErrID` (replacing the original `Hand_GetFingerErrID`) is used to retrieve the current error ID of the gripper. The error ID indicates the error type and designed to store the last error. Note that even if the gripper is recovered from an error state, the error ID does not reset automatically.

#### Basic examples

```
VAR num nLeftHandLastError;
nLeftHandLastError:= g_GetErrID();
```

#### Returned value

Data type: num

The function returns the value of current error ID.

#### Error handling

If the communication to the corresponding gripper fails, the error `ERR_NORUNUNIT` will be raised.

The following table provides some common hardware exceptions and related handling actions.

Error ID (HEX)	Error ID (BCD)	Description	Action
0x00	0	The system runs properly.	N/A
0x51	81	A wrong Hall sensor feedback is found in clockwise movement.	Check the connection between the Hall sensor output of the motor and the main board.
0x52	82	A wrong Hall sensor feedback is found in counter-clockwise movement.	Check the connection between the Hall sensor output of the motor and the main board.
0x58	88	There is an unexpected Hall sensor reading.	<ul style="list-style-type: none"> <li>Check the motor cable connection.</li> <li>Check the motor or PCB.</li> </ul>
0x63	99	The gripper is not calibrated.	Calibrate the gripper and try again.
0x64	100	The gripper is blocked.	Check whether there is anything blocking the gripper.
0x65	101	The object grasped by the gripper drops.	Increase the gripping force.
0xF0	240	The internal voltage is abnormal.	<ul style="list-style-type: none"> <li>Check the power supply of the gripper.</li> <li>Check the MPB.</li> </ul>
0xF1	241	The CPU temperature is over-high.	<ul style="list-style-type: none"> <li>Check the cooling system.</li> <li>Check the MPB.</li> </ul>

*Continues on next page*

## 5 RAPID references

---

### 5.3.1.5 g\_GetErrID - Get current gripper error ID

*Continued*

Error ID (HEX)	Error ID (BCD)	Description	Action
0xF2	242	The DC bus voltage is abnormal.	Check the power supply of the gripper.
0xF3	243	The DC bus current is too large.	Check the power supply of the gripper.

---

#### Syntax

```
g_GetErrID '('  
  [ Value ':' '=' ] <expression (IN) of num>  
  ')'
```

---

## 5.3.2 RAPID functions for pneumatic module

### 5.3.2.1 g\_GetPressure1 - Get vacuum pressure 1

---

#### Usages

`g_GetPressure1` (replacing the original `Hand_GetVacuumPressure1`) is used to retrieve the current vacuum pressure of pneumatic module 1. If the value 0 is returned, it means that no corresponding pneumatic module is included for this gripper or means there is no successful communication to the pressure sensor.

---

#### Basic examples

```
VAR num nLeftHandPressure1;  
nLeftHandPressure1:= g_GetPressure1();
```

---

#### Returned value

**Data type:** num

The function will return the value of that sensor in unit of kpa.

---

#### Error handling

If the communication to the corresponding gripper fails, the error `ERR_NORUNUNIT` will be raised.

---

#### Syntax

```
g_GetPressure1 '('  
  [ Value ':= ' ] <expression (IN) of num>  
' )'
```

## 5 RAPID references

---

### 5.3.2.2 g\_GetPressure2 - Get vacuum pressure 2

### 5.3.2.2 g\_GetPressure2 - Get vacuum pressure 2

---

#### Usages

`g_GetPressure2` (replacing the original `Hand_GetVacuumPressure2`) is used to retrieve the current vacuum pressure of pneumatic module 2. If the value 0 is returned, it means that no corresponding pneumatic module is included for this gripper or means there is no successful communication to the pressure sensor.

---

#### Basic examples

```
VAR num nLeftHandPressure2;  
nLeftHandPressure2:= g_GetPressure2();
```

---

#### Returned value

**Data type:** num

The function will return the value of that sensor in unit of kpa.

---

#### Error handling

If the communication to the corresponding gripper fails, the error `ERR_NORUNUNIT` will be raised.

---

#### Syntax

```
g_GetPressure2 '('  
  [ Value ':= ' ] <expression (IN) of num>  
  ')'
```

---



## 5.3.3 RAPID functions for camera module

### 5.3.3.1 g\_IsCamOnline - Get handheld camera connection status

---

#### Usages

`g_IsCamOnline` (replacing the original `Hand_IsCamConnected`) is used to retrieve the connection status of the handheld camera.

---

#### Basic examples

```
VAR bool isLeftCamConnected;  
isLeftCamConnected:= g_IsCamOnline();
```

---

#### Returned value

**Data type:** `bool`

The function will return the connection status of the handheld camera. The value `TRUE` is for connected, while `FALSE` for unconnected.

---

#### Error handling

If the communication to the corresponding gripper fails, the error `ERR_NORUNUNIT` will be raised.

---

#### Syntax

```
g_IsCamOnline '('  
  [ Value ':= ' ] <expression (IN) of num>  
' )'
```

**This page is intentionally left blank**

## 6 Decommissioning

### 6.1 Environmental information

#### Symbol

The following symbol indicates that the product must not be disposed of as common garbage. Handle each product according to local regulations for the respective content (see table below).

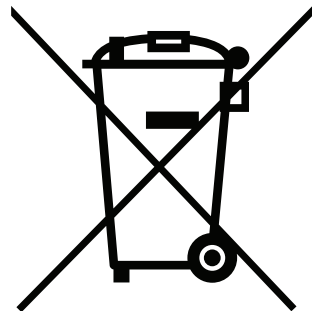

xx180000058

#### Hazardous material

The table specifies some of the materials in the product and their respective use throughout the product.

Dispose components properly according to local regulations to prevent health or environmental hazards.

Material	Example application
Aluminium	Other parts
Copper	Cables and motor
Magnesium	Base plate
Oil, grease	Linear guide, pinion and rack
Plastic/rubber	Cables, connectors, fingers, shell and vacuum units
Steel	Slide plates

#### Oil and grease

Where possible, arrange for oil and grease to be recycled. Dispose of via an authorized person/contractor in accordance with local regulations. Do not dispose of oil and grease near lakes, ponds, ditches, down drains, or onto soil. Incineration must be carried out under controlled conditions in accordance with local regulations.

Also note that:

- Spills can form a film on water surfaces causing damage to organisms. Oxygen transfer could also be impaired.
- Spillage can penetrate the soil causing ground water contamination.

**This page is intentionally left blank**

# 7 Reference information

## 7.1 Introduction

---

### General

This chapter includes general information, complementing the more specific information in the different procedures in the manual.

## 7 Reference information

---

### 7.2 Unit conversion

### 7.2 Unit conversion

---

#### Converter table

Use the following table to convert units used in this manual.

Quantity	Units		
Length	1 m	3.28 ft.	39.37 in
Weight	1 kg	2.21 lb.	
Weight	1 g	0.035 ounces	
Pressure	1 bar	100 kPa	14.5 psi
Force	1 N	0.225 lbf	
Moment	1 Nm	0.738 lbf-ft	
Volume	1 L	0.264 US gal	

---

## 7.3 Standard toolkit

---

### General

All service (repairs, maintenance, and installation) procedures contains lists of tools required to perform the specified activity.

All special tools required are listed directly in the procedures while all the tools that are considered standard are gathered in the standard toolkit and defined in the following table.

This way, the tools required are the sum of the standard toolkit and any tools listed in the instruction.

---

### Contents, standard toolkit

Qty	Tool	Rem.
1	Slot screwdriver for M1.2	
1	Socket head cap screwdriver for M1.6	
1	Socket head cap screwdriver for M2	
1	Socket head cap screwdriver for M2.5	
1	Plus screwdriver M2	
1	Torx screwdriver M2	
1	Tweezer	

**This page is intentionally left blank**



## 8 Spare parts

### 8.1 Introduction

---

#### General

This chapter include spare part lists and spare part illustrations for the IRB 14000 gripper and all its variants.

---

#### Spare part level

ABB spare parts are categorized into two levels, L1 and L2. Always check the part level before conducting a service work on a spare part.

- L1 spare parts

The L1 parts can be replaced in the field. The maintenance and replacement instructions given in the related product manuals must be strictly followed. If there are any problems, contact your local ABB for support.

- L2 spare parts

To replace the L2 parts require specialized training and might need special tools. Only ABB field service personnel or qualified personnel trained by ABB can replace L2 parts.

## 8 Spare parts

### 8.2.1 Parts

## 8.2 Spare part lists and illustrations

### 8.2.1 Parts

#### Spare part list and exploded view for servo with vacuum and vision

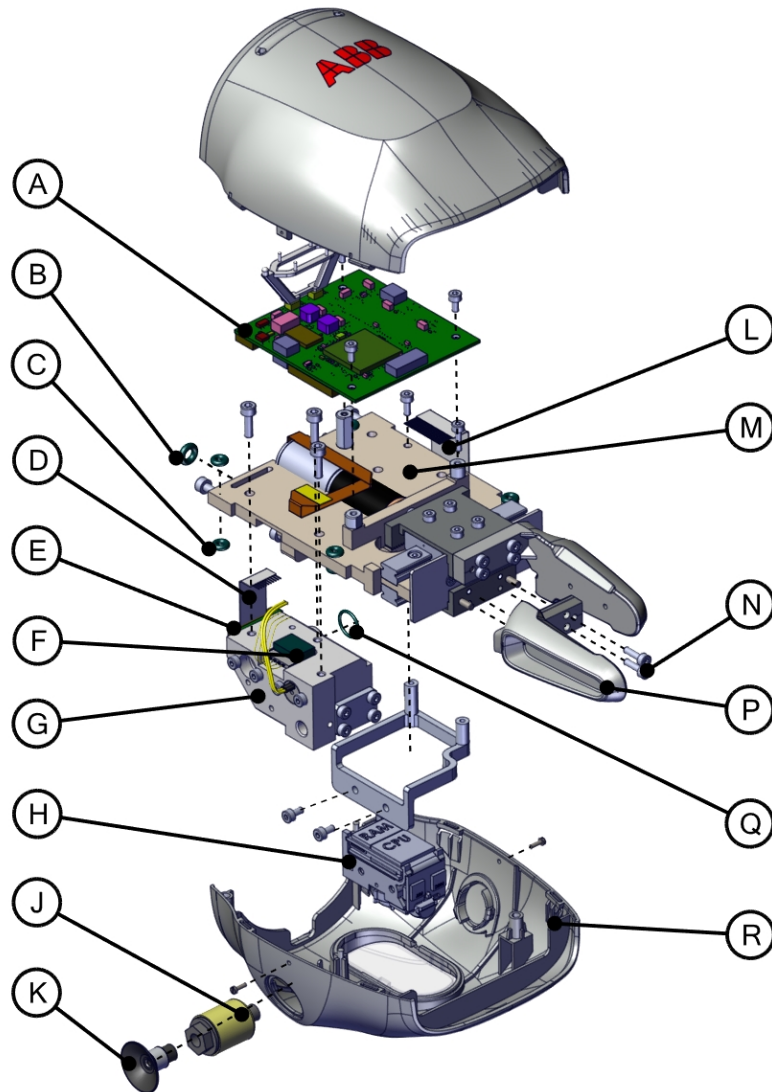

xx150000640

Pos	Article number	Description	Spare part level	Qty
A	3HAC051608-001	Main PCB	L1	1
B	3HAC063220-001	O-ring 4x2	L1	1
C	3HAB3772-175	O-ring 1.8x1.8	L1	1
D	3HAC051610-002	FFC for pneumatic block connector board	L1	1
E	3HAC051609-001	Pneumatic block connector board	L1	1

*Continues on next page*

## 8 Spare parts

### 8.2.1 Parts

*Continued*

Pos	Article number	Description	Spare part level	Qty
F	3HAC047823-001	Vacuum sensor	L1	1
G	3HAC054989-001	Pneumatic block	L1	1
H	3HAC051676-001	Camera AE3	L1	1
J	3HAC047854-001	Vacuum filter	L1	2
K	3HAC047927-001	Vacuum rubber cup	L1	2
L	3HAC054157-002	FFC for camera	L1	1
M	3HAC065996-001	Servo base	L1	1
N	3HAC051700-001	Hex socket head cap screw (M2x7)	L1	8
P	3HAC052976-001	Fingers  <b>Note</b> Gripper fingers are wear parts.	L1	1
Q	3HAB3772-173	O-ring 7x1	L1	1
R	3HAC066000-001	Shell complete (with camera window)	L1	1

*Continues on next page*

## 8 Spare parts

### 8.2.1 Parts

Continued

#### Spare part list and exploded view for servo with vacuum1 and vacuum2

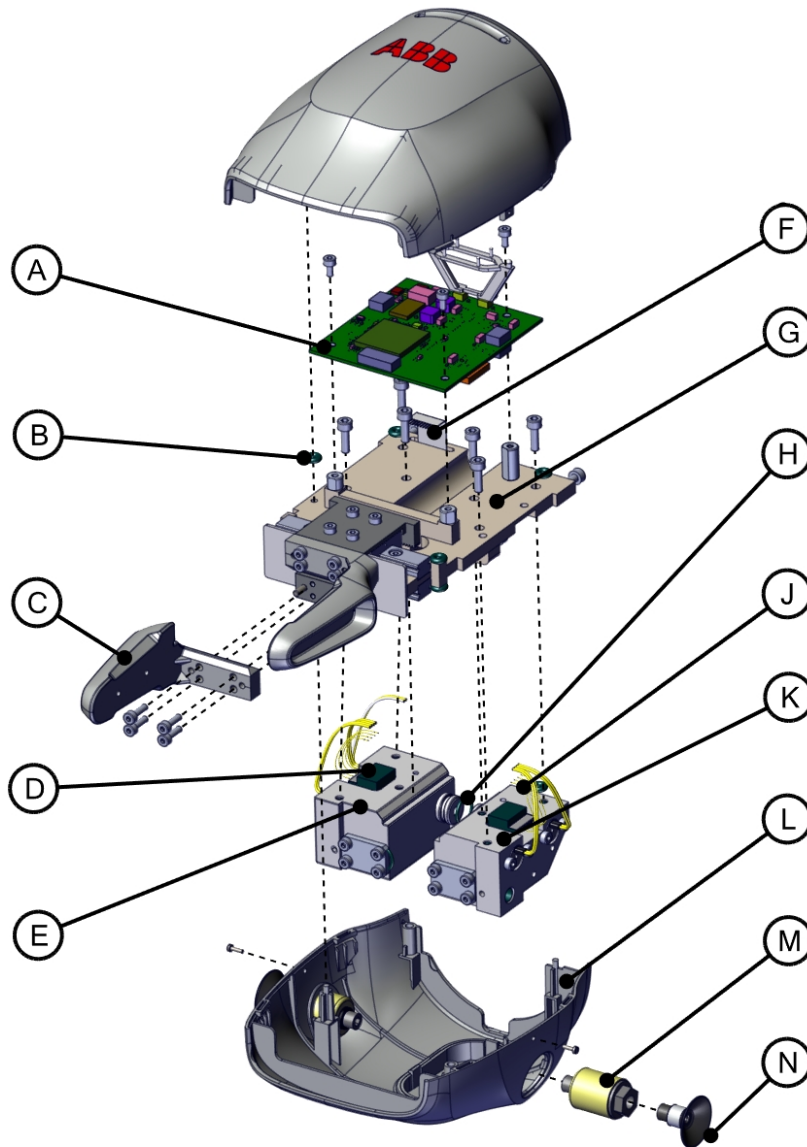

xx150000641

Pos	Article number	Description	Spare part level	Qty
A	3HAC051608-001	Main PCB	L1	1
B	3HAB3772-175	O-ring 1.8x1.8	L1	1
C	3HAC052976-001	Fingers  <b>Note</b> Gripper fingers are wear parts.	L1	1
D	3HAC047823-001	Vacuum sensor	L1	2
E	3HAC054989-001	Pneumatic block	L1	1

Continues on next page

## 8 Spare parts

### 8.2.1 Parts

*Continued*

Pos	Article number	Description	Spare part level	Qty
F	3HAC051610-002	FFC for pneumatic block connector board	L1	2
G	3HAC065996-001	Servo base	L1	1
H	3HAB3772-173	O-ring 7x1	L1	1
K	3HAC054990-001	Pneumatic block	L1	1
J	3HAC051609-001	Pneumatic block connector board	L1	2
L	3HAC066001-001	Shell complete (without camera window)	L1	1
M	3HAC047854-001	Vacuum filter	L1	2
N	3HAC047927-001	Vacuum rubber cup	L1	2

**This page is intentionally left blank**

# Index

## A

air consumption, 24  
aluminum  
  disposal, 151  
ambient humidity  
  operation, 20  
  storage, 20  
ambient temperature  
  operation, 20  
  storage, 20

## C

copper  
  disposal, 151

## E

environmental information, 151

## G

g\_BlowOff1, 133  
g\_BlowOff2, 135  
g\_BlowOn1, 132  
g\_BlowOn2, 134  
g\_Calibrate, 129  
g\_GetErrID, 145  
g\_GetPos, 141  
g\_GetPressure1, 147  
g\_GetPressure2, 148  
g\_GetSpd, 142  
g\_GetState, 143  
g\_GripIn, 123  
g\_GripOut, 126  
g\_Init, 117  
g\_IsCalibrated, 140  
g\_IsCamOnline, 149  
g\_JogIn, 119  
g\_JogOut, 120  
g\_MoveTo, 121  
g\_SetMaxSpd, 131  
g\_Stop, 130  
g\_VacuumOff1, 137  
g\_VacuumOff2, 139  
g\_VacuumOn1, 136

g\_VacuumOn2, 138

grease  
  disposal, 151

## H

hazardous material, 151  
humidity  
  operation, 20  
  storage, 20

## M

magnesium  
  disposal, 151

## O

oil  
  disposal, 151

## P

plastic  
  disposal, 151  
pneumatic module  
  air consumption, 24  
protection classes, 20  
protection type, 20

## R

RAPID function, 140–143, 145, 147–149  
RAPID instruction, 117, 119–121, 123, 126, 129–139  
robot  
  protection class, 20  
  protection types, 20  
rubber  
  disposal, 151

## S

safety  
  introduction, 13  
steel  
  disposal, 151  
storage conditions, 20

## T

temperatures  
  operation, 20  
  storage, 20









**ABB AB**

**Robotics & Discrete Automation**

S-721 68 VÄSTERÅS, Sweden

Telephone +46 (0) 21 344 400

**ABB AS**

**Robotics & Discrete Automation**

Nordlysvegen 7, N-4340 BRYNE, Norway

Box 265, N-4349 BRYNE, Norway

Telephone: +47 22 87 2000

**ABB Engineering (Shanghai) Ltd.**

Robotics & Discrete Automation

No. 4528 Kangxin Highway

PuDong District

SHANGHAI 201319, China

Telephone: +86 21 6105 6666

**ABB Inc.**

**Robotics & Discrete Automation**

1250 Brown Road

Auburn Hills, MI 48326

USA

Telephone: +1 248 391 9000

**[abb.com/robotics](http://abb.com/robotics)**